

**Block Type EMIFIL® BNX01□-01 Reference Specification****1. Scope**

This reference specification applies to Block Type EMIFIL®.

**2. Rating**

2.1	Customer Part Number		
2.2	Murata Part Number	BNX012-01	BNX016-01
2.3	Rated Voltage	50 V(DC)	25 V(DC)
2.4	Test Voltage	125 V(DC)	62.5 V(DC)
2.5	Rated Current (*1)	15 A(DC)	
2.6	Insulation Resistance	500 MΩ min.	50 MΩ min.
2.7	Voltage Drop	35 mV max.	
2.8	Capacitance	1.0 μF ± 15 %	10 μF ± 10 %
2.9	Insertion Loss	1 MHz to 1 GHz :	100 kHz to 1 GHz :
		40dB min.	40dB min.
		Line impedance = 50 Ω	
2.10	Equivalent Circuits	See the item 4	
2.11	Operating Temperature	- 40 °C ~ + 125 °C	
2.12	Storage Temperature	- 55 °C ~ + 125 °C	

(\*1)

Rated current is derated according to operating temperature, as shown in the right hand graph.

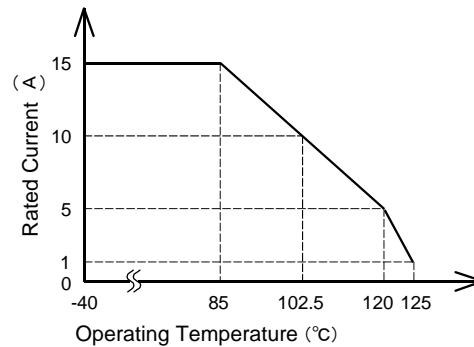
**3. Standard Testing Condition**

<Unless otherwise specified>

Temperature : Ordinary Temp. 15 °C to 35 °C

Humidity : Ordinary Humidity 25 %(RH) to 85 %(RH)

<In case of doubt>

Temperature : 20 °C ± 2 °C (BNX012-01)

Temperature : 25 °C ± 2 °C (BNX016-01)

Humidity : 60 %(RH) to 70 %(RH)

Atmospheric pressure : 86 kPa to 106 kPa

**4. Style and Dimensions**

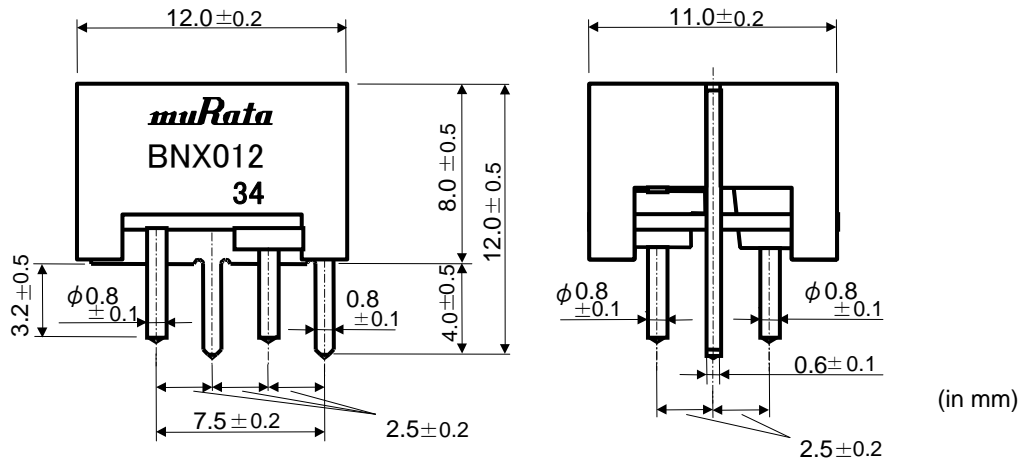

( The tip by solder of terminal is not included in the dimension values. )

Note) Although some part of the product surface seems to be white in some cases, do not care because it is the result of waxing process for humidity resistance improvement. This wax does not make bad affection to mechanical or electrical performance, reliability of the product.

• TERMINAL LAYOUT (BOTTOM FIGURE)

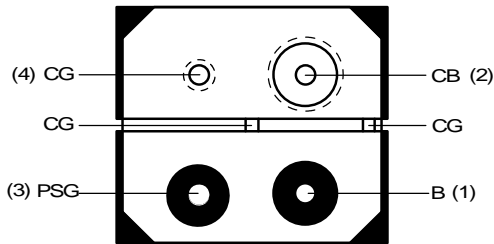

• DIMENSIONS OF INSTALLATION HOLES

(front view)

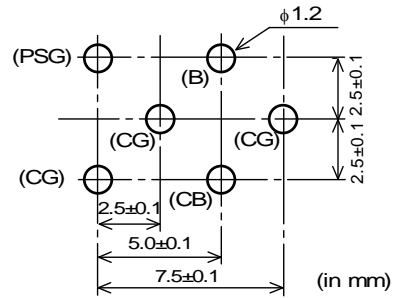

• EQUIVALENT CIRCUIT

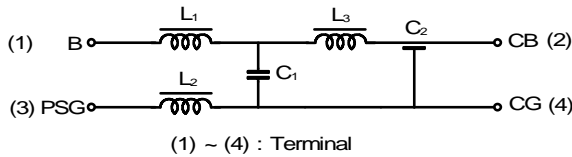

- B : Bias
- PSG : Power Supply Ground
- CG : Circuit Ground
- CB : Circuit + Bias

• Unit Mass (Typical value)

2.0g

**5. Marking**

Filter shall be marked as follows.

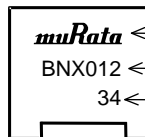

- ← Murata mark
- ← Part Number (Type name)
- ← Manufacturing Date

(Ex.) 34  
 3 ... 2003 (Last digit of the year)  
 4 ... April  
 ( Jan. to Sept. 1 ~ 9  
 Oct. : O , Nov. : N , Dec. : D )

**6. Electrical Performance**

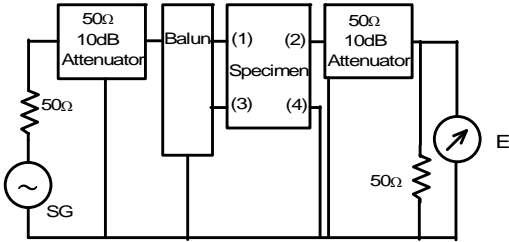
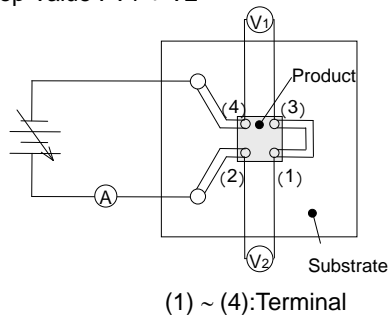
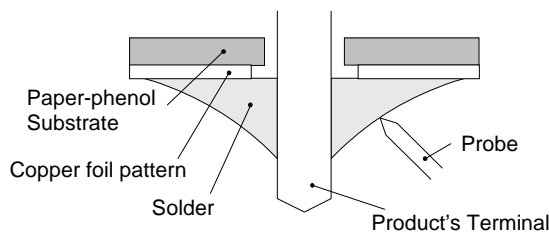
No.	Item	Specification	Test Method
6.1	Insulation Resistance	Meet item 2.6.	Measured at DC rated voltage between terminal (1)(2) and (3)(4). Time : 2 minutes Suitable resistor : 1MΩ.
6.2	Dielectric Strength	Filter shall be no failure.	Test voltage shall be applied between terminal (1)(2) and terminal (3)(4). Time : 1 to 5 seconds. Charging current : 50 mA max.
6.3	Capacitance	Meet item 2.8.	Measured at the following condition between terminal (1)(2) and (3)(4). Frequency : 1 ± 0.1kHz Voltage : 1 V(rms) max.
6.4	Insertion Loss	Meet item 2.9.	 <p>*Method of measurement based on MIL-STD-220</p> <p>Insertion Loss = <math>20 \log (E_0 / E_1)</math>  <math>E_0</math> : Level without FILTER (short)  <math>E_1</math> : Level with FILTER</p>
6.5	Voltage Drop	Meet item 2.7.	<p>Rated Current : 15 A                  Substrate : 100 × 100 × 1.6mm (paper-phenol)                  Soldering : Insert the terminals into the holes on P.C. board completely.                  Voltage Drop Value : V1 + V2</p>  <p>(1) ~ (4):Terminal</p> <p>Probe of each voltmeter shall be contacted to the center of soldering parts as following figure.</p> 

**7. Mechanical Performance**

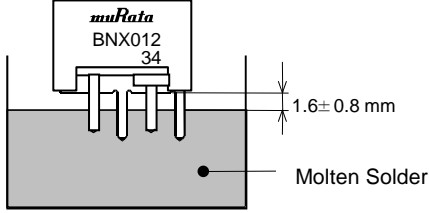
No.	Item	Specification	Test Method								
7.1	Appearance and Dimensions	Meet item 4.	Visual Inspection and measured with Slide Calipers.								
7.2	Marking	Marking is able to be read easily.	It is inspected Visually.								
7.3	Vibration	Meet Table 1.  <table border="1"> <caption>Table 1</caption> <tr> <td>Appearance</td> <td>No damaged</td> </tr> <tr> <td>Insulation Resistance</td> <td>Meet item 2.6</td> </tr> <tr> <td>Dielectric Strength</td> <td>No failure</td> </tr> <tr> <td>Capacitance</td> <td>Meet item 2.8</td> </tr> </table>	Appearance	No damaged	Insulation Resistance	Meet item 2.6	Dielectric Strength	No failure	Capacitance	Meet item 2.8	It shall be soldered on the substrate.  Range of Vibration Frequency : 10 to 2000 to 10Hz for 20 minutes Testing Time : A period of 3 hours in each of 3 mutually perpendicular directions (Total 9 hours) Total amplitude 1.5 mm or Acceleration amplitude $196 \text{ m/s}^2$ whichever is smaller. Then measure values after exposure in the room condition for 4 to 24 hours.
Appearance	No damaged										
Insulation Resistance	Meet item 2.6										
Dielectric Strength	No failure										
Capacitance	Meet item 2.8										
7.4	Solderability	Then the lead is covered with a continuous new solder coating at least 90% along the circumference of the immersed part.	Flux : Ethanol solution of rosin, 25(wt)% Pre-heat : $150 \pm 10 \text{ }^\circ\text{C}$ , 60 ~ 90 s Solder : Sn-3.0Ag-0.5Cu Solder Temperature $245 \pm 5 \text{ }^\circ\text{C}$ Immersion Time : $2 \pm 0.5$ seconds  								
7.5	Resistance to soldering heat	Meet Table 2.  <table border="1"> <caption>Table 2</caption> <tr> <td>Appearance</td> <td>No damaged</td> </tr> <tr> <td>Insulation Resistance</td> <td>Meet item 2.6</td> </tr> <tr> <td>Dielectric Strength</td> <td>No failure</td> </tr> <tr> <td>Capacitance Change</td> <td>within <math>\pm 7.5\%</math></td> </tr> </table>	Appearance	No damaged	Insulation Resistance	Meet item 2.6	Dielectric Strength	No failure	Capacitance Change	within $\pm 7.5\%$	Flux : Ethanol solution of rosin, 25(wt)% Pre-heat : $150 \pm 10 \text{ }^\circ\text{C}$ , 60 ~ 90 s Solder : Sn-3.0Ag-0.5Cu Solder Temperature : $270 \pm 10 \text{ }^\circ\text{C}$ Immersion Time : 10s (+ 2s , - 0s) Then measure values after exposure in the room condition for 24 to 48 hours.
Appearance	No damaged										
Insulation Resistance	Meet item 2.6										
Dielectric Strength	No failure										
Capacitance Change	within $\pm 7.5\%$										

**8. Environmental Performance**

The test shall be carried out after the product is soldered on the substrate.

No.	Item	Specification	Test Method						
8.1	Temperature Cycle	Meet Table 2.	1 Cycle 1 step : - 55 °C (+ 0°C , - 3°C) / 30 minutes 2 step : Room Temperature / within 30 s 3 step : + 125 °C (+ 3°C , - 0°C) / 30 minutes 4 step : Room Temperature / within 30 s Total of 1000 cycle Then measure values after exposure in the room condition for 24 to 48 hours.						
8.2	Humidity Life	Meet Table 3. <u>Table 3</u> <table border="1"> <tr> <td>Appearance</td> <td>No damaged</td> </tr> <tr> <td>Insulation Resistance</td> <td>25 MΩ min. (BNX012-01) 2.5 MΩ min. (BNX016-01)</td> </tr> <tr> <td>Capacitance Change</td> <td>within ± 12.5%</td> </tr> </table>	Appearance	No damaged	Insulation Resistance	25 MΩ min. (BNX012-01) 2.5 MΩ min. (BNX016-01)	Capacitance Change	within ± 12.5%	Temperature : 60 ± 2 °C Humidity : 90 ~ 95 %(RH) Voltage : Rated Voltage Time : 1000 h (+ 48h , - 0h) Remove the drops and then measure values after exposure in the room condition for 24 to 48 hours.
Appearance	No damaged								
Insulation Resistance	25 MΩ min. (BNX012-01) 2.5 MΩ min. (BNX016-01)								
Capacitance Change	within ± 12.5%								
8.3	Heat Life	Meet Table 4. <u>Table 4</u> <table border="1"> <tr> <td>Appearance</td> <td>No damaged</td> </tr> <tr> <td>Insulation Resistance</td> <td>50 MΩ min. (BNX012-01) 5.0 MΩ min. (BNX016-01)</td> </tr> <tr> <td>Capacitance Change</td> <td>within ± 12.5%</td> </tr> </table>	Appearance	No damaged	Insulation Resistance	50 MΩ min. (BNX012-01) 5.0 MΩ min. (BNX016-01)	Capacitance Change	within ± 12.5%	Temperature : 125 ± 2 °C Voltage : Rated Voltage × 2 (BNX012-01) Voltage : Rated Voltage × 1.5 (BNX016-01) Time : 1000 h (+ 48h , - 0h) Then measure values after exposure in the room condition for 24 to 48 hours.
Appearance	No damaged								
Insulation Resistance	50 MΩ min. (BNX012-01) 5.0 MΩ min. (BNX016-01)								
Capacitance Change	within ± 12.5%								

**9. Specification of Packaging****9.1. Packing Quantity**

Individual packaging
150pcs

**9.2. Packing Method**

Styrene foam boards which have 50 pcs of the stuck products on are placed in an Individual packaging as 3 steps.  
A quantity in an Outer packaging is depending on a quantity of an order.

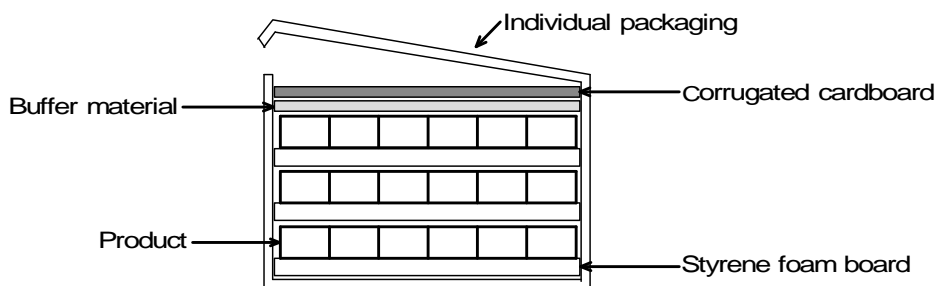

In some cases , omit the Buffer material and/or Currugated cardboard.



## 11. Notice

### 11.1. Using the block type EMIFIL® (BNX) effectively

This product effectively prevents undesired radiation and external noise from going out / entering the circuit by grounding the high frequency components which cause noise problem. Therefore, grounding condition may affect on the performance of the filter and following attentions should be paid for effective use.

- (1) Design maximized grounding area in the P.C. board, and grounding pattern for all the grounding terminals of the product to be connected. (Recommended to use our recommendation in this spec.)
- (2) Minimize the distance between ground of the P.C. board and the ground plate of the product. (Recommended to use through-hole connection between grounding area both of component side and bottom side.)
- (3) Insert the terminals into the holes on P.C. board completely.
- (4) Don't connect PSG terminal with CG terminal directly. (See the item 4. TERMINAL LAYOUT)

### 【 P.C. BOARD PATTERNS 】

Use a bilateral P.C.board. Insert the BNX into the P.C.board until the root of the terminal is secured, then solder.

(1) COMPONENT SIDE VIEW (2) BOTTOM VIEW

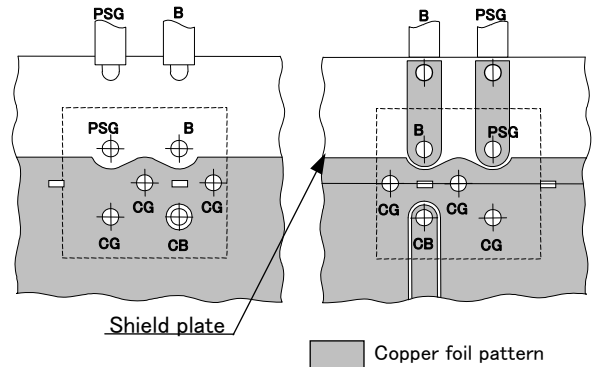

### 11.2. Self-heating

Though this product has a large rated current, the localized self-heating may be caused depending on soldering conditions. To avoid this, following attention should be paid.

- (1) Use P.C. board with our recommendation on hole diameter / land pattern dimensions, mentioned in the right hand drawing, especially for 4 terminals which pass current.
- (2) Solder the terminals to the P.C.board with solder-cover area at least 90%. Otherwise, excess self-heating at connection between terminals and P.C. board may lead to smoke and / or fire of the product even when operating at rated current.
- (3) After installing this product in your product, please make sure of the self-heating with the rated current.

### 【 Recommendation land pattern 】

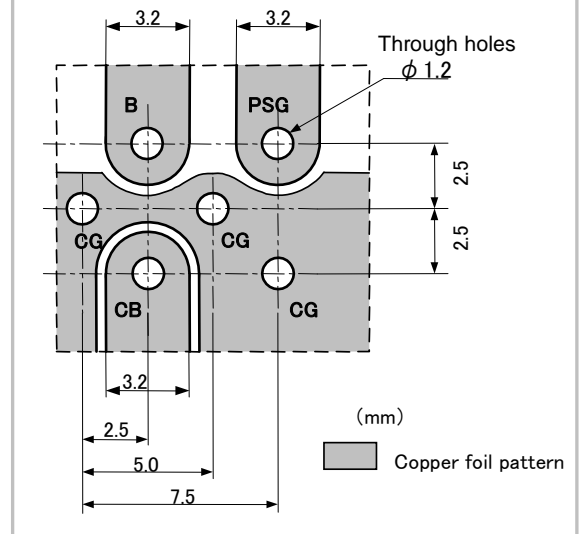

**11.3. Soldering**

## (1) Flux, Solder

- Rosin-based flux should be used.  
Do not use strong acidic flux with halide content exceeding 0.2(wt)% (chlorine conversion value.)
- Use Sn-3.0Ag-0.5Cu solder.

## (2) Standard flow soldering profile.

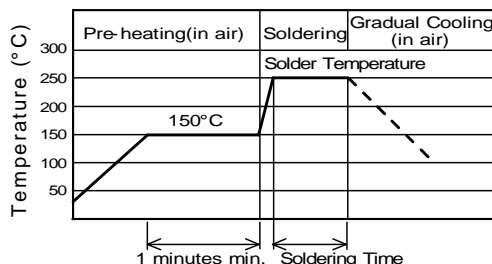

Solder Temperature	Soldering Time
250 ~ 260 °C	4 ~ 6 s

- (3) Resistance to soldering iron goes in the following condition that tip temperature is 350 °C max. and soldering time is 5 s max.
- (4) Products and the leads should not be subjected to any mechanical stress during soldering process. (and also while subjected to the equivalent high temperature.)

**11.4. Cleaning Conditions**

Products shall be cleaned on the following conditions.

- (1) Cleaning temperature shall be limited to 60 °C max. (40 °C max. for IPA.)
- (2) Ultrasonic cleaning shall comply with the following conditions, with avoiding the resonance phenomenon at the mounted products and P.C.B.

Power : 20W / l max.      Frequency : 28kHz to 40kHz      Time : 5 minutes max.

## (3) Cleaner

## 1. Cleaner

- Isopropyl alcohol (IPA)

## 2. Aqueous agent

- Higher Alcohol Type (PINE ALPHA ST-100S)

## (4) There shall be no residual flux and residual cleaner after cleaning.

In the case of using aqueous agent, products shall be dried completely after rinse with de-ionized water in order to remove the cleaner.

## (5) The surface of products may become dirty whitely after cleaning.

But there is no deterioration on mechanical, electrical characteristics and reliability.

## (6) Other cleaning

Please contact us.

**11.5. Operating Environment**

- (1) Do not use products in corrosive gases such as chlorine gas, acid or sulfide gas.
- (2) Do not use products in the environment where water, oil or organic solvents may adhere to product.

**11.6. Storage condition**

## (1) Storage period

Use the products within 12 months after delivered.  
Solderability should be checked if this period is exceeded.

## (2) Storage environment condition

- Products should be stored in the warehouse on the following conditions.

Temperature : - 10 °C to + 40 °C

Humidity : 15 % to 85% relative humidity      No rapid change on temperature and humidity



- Don't keep products in corrosive gases such as sulfur, chlorine gas or acid, or it may cause oxidization of electrode, resulting in poor solderability.
- Products should be stored on the palette for the prevention of the influence from humidity, dust and so on.
- Products should be stored in the warehouse without heat shock, vibration, direct sunlight and so on.
- Products should be stored under the airtight packaged condition.

(3) Delivery

Care should be taken when transporting or handling product to avoid excessive vibration or mechanical shock.

**12.  Notes**

- (1) Please make sure that your product has been evaluated in view of your specifications with our product being mounted to your product.
- (2) You are requested not to use our product deviating from the reference specifications.
- (3) The contents of this reference specification are subject to change without advance notice. Please approve our product specifications or transact the approval sheet for product specifications before ordering.

# Mouser Electronics

Authorized Distributor

Click to View Pricing, Inventory, Delivery & Lifecycle Information:

[Murata:](#)

[BNX016-01](#) [BNX012-01](#)