

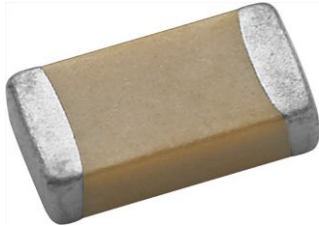

Surface Mount Multilayer Ceramic Chip Capacitors for Automotive Applications



FEATURES

- AEC-Q200 qualified with PPAP available
- Available in 0402 to 1812 body size
- Four dielectric materials
- AgPd termination available for silver epoxy bonding
- High operating temperature
- Wet build process
- Reliable Noble Metal Electrode (NME) system
- Parts compliant with ELV directive
- Material categorization: for definitions of compliance please see www.vishay.com/doc?99912

AUTOMOTIVE
GRADERoHS*
Available
HALOGEN
FREE

Note

* This datasheet provides information about parts that are RoHS-compliant and / or parts that are non-RoHS-compliant. For example, parts with lead (Pb) terminations are not RoHS-compliant. Please see the information / tables in this datasheet for details.

For more than 25 years Vishay Vitramon has supported the automotive industry with robust, highly reliable MLCCs that have made it a leader in this segment. All Vishay Vitramon MLCCs are manufactured in "Precious Metal Technology" (PMT / NME) and a wet build process. They are qualified according to AEC-Q200 with PPAP available on request. Applications for these devices include automotive "under the hood", safety and comfort electronics. Their termination finish is 100 % matte tin plate finish and AgPd which is used with silver epoxy bonding. A polymer (flexible) termination with 100 % matte tin plate finish is offered for boardflex sensitive applications.

COG (NP0) DIELECTRIC

GENERAL SPECIFICATION

Note

Electrical characteristics at +25 °C unless otherwise specified

Operating Temperature: -55 °C to +150 °C
(above +125 °C changed characteristics, see 2.3)

Capacitance Range: 1 pF to 22 nF

Voltage Range: 25 V_{DC} to 3000 V_{DC}

Temperature Coefficient of Capacitance (TCC):
0 ppm/°C ± 30 ppm/°C from -55 °C to +125 °C

Dissipation Factor (DF):

0.1 % maximum at 1.0 V_{RMS} and
1 MHz for values ≤ 1000 pF
0.1 % maximum at 1.0 V_{RMS} and
1 kHz for values > 1000 pF

Insulating Resistance:

at +25 °C 100 000 MΩ min. or 1000 ΩF whichever is less
at +125 °C 10 000 MΩ min. or 100 ΩF whichever is less

Aging: 0 % maximum per decade

Dielectric Strength Test:

performed per method 103 of EIA 198-2-E.

Applied test voltages

| | |
|--|------------------------|
| ≤ 250 V _{DC} -rated: | 250 % of rated voltage |
| 500 V _{DC} -rated: | 200 % of rated voltage |
| 630 V _{DC} , 1000 V _{DC} -rated: | 150 % of rated voltage |
| 3000 V _{DC} -rated: | 120 % of rated voltage |

X7R, X8R DIELECTRIC

GENERAL SPECIFICATION

Note

Electrical characteristics at +25 °C unless otherwise specified

Operating Temperature: -55 °C to +150 °C
(X7R above +125 °C changed characteristics, see 2.3)

Capacitance Range: 120 pF to 1.0 μF

Voltage Range: 16 V_{DC} to 1000 V_{DC}

Temperature Coefficient of Capacitance (TCC):

X7R: ± 15 % from -55 °C to +125 °C, with 0 V_{DC} applied
X8R: ± 15 % from -55 °C to +150 °C, with 0 V_{DC} applied

Dissipation Factor (DF):

10 V ratings: 5 % maximum at 1.0 V_{RMS} and 1 kHz
16 V, 25 V ratings: 3.5 % maximum at 1.0 V_{RMS} and 1 kHz
> 25 V ratings: 2.5 % maximum at 1.0 V_{RMS} and 1 kHz

Insulating Resistance:

at +25 °C 100 000 MΩ min. or 1000 ΩF whichever is less
at +125 °C 10 000 MΩ min. or 100 ΩF whichever is less

Aging Rate: 1 % maximum per decade

Dielectric Strength Test:

performed per method 103 of EIA 198-2-E.

Applied test voltages

| | |
|--|-----------------------------|
| ≤ 250 V _{DC} -rated: | 250 % of rated voltage |
| 500 V _{DC} -rated: | min. 150 % of rated voltage |
| 630 V _{DC} , 1000 V _{DC} -rated: | min. 120 % of rated voltage |



| QUICK REFERENCE DATA | | | | |
|-----------------------------|-----------|---------------------|-------------|-------------|
| DIELECTRIC | CASE CODE | MAXIMUM VOLTAGE (V) | CAPACITANCE | |
| | | | MINIMUM | MAXIMUM |
| COG (NP0) | 0402 | 100 | 1.0 pF | 220 pF |
| | 0603 | 200 | 1.0 pF | 1.0 nF |
| | 0805 | 500 | 1.0 pF | 3.9 nF |
| | 1206 | 630 | 1.0 pF | 10 nF |
| | 1210 | 630 | 100 pF | 12 nF |
| | 1812 | 3000 | 12 pF | 22 nF |
| X7R | 0402 | 100 | 120 pF | 47 nF |
| | 0603 | 200 | 330 pF | 150 nF |
| | 0805 | 500 | 330 pF | 470 nF |
| | 1206 | 630 | 220 pF | 1.0 μ F |
| | 1210 | 630 | 390 pF | 1.0 μ F |
| | 1812 | 630 | 10 nF | 1.0 μ F |
| X8R | 0402 | 100 | 330 pF | 6.8 nF |
| | 0603 | 100 | 470 pF | 33 nF |
| | 0805 | 100 | 470 pF | 100 nF |
| | 1206 | 50 | 1.0 nF | 220 nF |
| | 1210 | 50 | 10 nF | 390 nF |

Note

- Detail ratings see "Selection Chart"



| ORDERING INFORMATION - TIN TERMINATION | | | | | | | | |
|--|-------------------------------------|--|---|---|---|---|--|---|
| VJ0805 ⁽²⁾ | Y | 102 | K | X | A | A | C | 31 |
| CASE CODE | DIELECTRIC | CAPACITANCE NOMINAL CODE ⁽⁴⁾ | CAPACITANCE TOLERANCE | TERMINATION | DCVOLTAGE RATING ⁽¹⁾ | MARKING | PACKAGING | PROCESS CODE |
| 0402 0603 0805 1206 1210 1812 | A = C0G (NP0) Y = X7R H = X8R | Expressed in picofarads (pF). The first two digits are significant, the third is a multiplier. An "R" indicates a decimal point. Examples 4R7 = 4.7 pF 102 = 1000 pF | B = ± 0.10 pF C = ± 0.25 pF D = ± 0.5 pF F = ± 1 % G = ± 2 % J = ± 5 % K = ± 10 % M = ± 20 % Note: C0G (NP0): B, C, D < 10 pF F, G, J, K ≥ 10 pF X7R / X8R: J, K, M | X = Ni barrier 100 % matte tin plate finish B = polymer 100 % matte tin plate finish ⁽³⁾⁽⁷⁾ | J = 16 V X = 25 V A = 50 V B = 100 V C = 200 V P = 250 V E = 500 V L = 630 V G = 1000 V H = 3000 V | A = unmarked B = marked Note: marking is only available for 0805 and 1206 vendor ID and date code | E / T = 7" reel / plastic tape ⁽⁵⁾ C = 7" reel / paper tape M / R = 11 1/4" / 13" reel / plastic tape ⁽⁵⁾ P = 11 1/4" / 13" reel / paper tape | 31 = automotive 100 % matte tin plate finish |

| ORDERING INFORMATION - SILVER PALLADIUM TERMINATION | | | | | | | | |
|---|-------------------------------------|--|---|-------------------------------|---|--|---|--------------------------------|
| VJ0805 ⁽²⁾ | Y | 102 | K | F | A | A | O | 34 |
| CASE CODE | DIELECTRIC | CAPACITANCE NOMINAL CODE ⁽⁴⁾ | CAPACITANCE TOLERANCE | TERMINATION | DCVOLTAGE RATING ⁽¹⁾ | MARKING | PACKAGING | PROCESS CODE |
| 0402 0603 0805 1206 1210 1812 | A = C0G (NP0) Y = X7R H = X8R | Expressed in picofarads (pF). The first two digits are significant, the third is a multiplier. An "R" indicates a decimal point. Examples 102 = 1000 pF | B = ± 0.10 pF C = ± 0.25 pF D = ± 0.5 pF F = ± 1 % G = ± 2 % J = ± 5 % K = ± 10 % M = ± 20 % Note: C0G (NP0): B, C, D < 10 pF F, G, J, K ≥ 10 pF X7R / X8R: J, K, M | F, E = AgPd ⁽⁶⁾⁽⁷⁾ | J = 16 V X = 25 V A = 50 V B = 100 V C = 200 V P = 250 V E = 500 V L = 630 V G = 1000 V H = 3000 V | A = unmarked Note: marking is not available | E / T = 7" reel / plastic tape ⁽⁵⁾ O = 7" reel / flamed paper tape M / R = 11 1/4" / 13" reel / plastic tape ⁽⁵⁾ I = 11 1/4" / 13" reel / flamed paper tape Note: "I" and "O" are used for "F", "E" termination size 0402 / 0603 / 0805 | 34 = automotive AgPd finish |

Notes

- (1) DC voltage rating should not be exceeded in application. Other application factors may affect the MLCC performance. Consult for questions: mlcc@vishay.com
- (2) Case size designator may be replaced by a four digit drawing number
- (3) Polymer termination contact mlcc@vishay.com for availability of ratings
- (4) Non-standard values please contact: mlcc@vishay.com for availability
- (5) Packaging "T" and "R" is used for 1812 size
- (6) Termination code "E" is for conductive epoxy assembly.
- (7) Termination code "B" and "F" are not available with X8R in 0402, 0603 - 100 V, 0805 - 100 V.



VJ....31 / VJ....34 Automotive MLCC

Vishay Vitramon

DIMENSIONS in inches (millimeters)

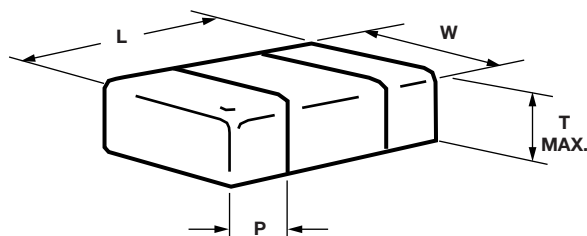

| CASE CODE | STYLE | LENGTH (L) | WIDTH (W) | MAXIMUM THICKNESS (T) | TERMINATIONS PAD (P) | |
|-----------|--------|---|---|-----------------------|----------------------|-----------------|
| | | | | | MINIMUM | MAXIMUM |
| 0402 | VJ0402 | 0.040 + 0.004 / - 0.002 (1.00 + 0.10 / - 0.05) | 0.020 + 0.004 / - 0.002 (0.50 + 0.10 / - 0.05) | 0.024 (0.60) | 0.004 (0.10) | 0.016 (0.41) |
| 0603 | VJ0603 | 0.063 ± 0.006 (1.60 ± 0.15) | 0.031 ± 0.006 (0.80 ± 0.15) | 0.038 (0.97) | 0.012 (0.30) | 0.018 (0.46) |
| 0805 | VJ0805 | 0.079 ± 0.008 (2.00 ± 0.20) | 0.049 ± 0.008 (1.25 ± 0.20) | 0.057 (1.45) | 0.010 (0.25) | 0.028 (0.71) |
| 1206 | VJ1206 | 0.126 ± 0.010 (3.20 ± 0.25) | 0.063 ± 0.010 (1.60 ± 0.25) | 0.067 (1.70) | 0.010 (0.25) | 0.028 (0.71) |
| 1210 | VJ1210 | 0.126 ± 0.010 (3.20 ± 0.25) | 0.098 ± 0.010 (2.50 ± 0.25) | 0.076 (1.94) | 0.010 (0.25) | 0.028 (0.71) |
| 1812 | VJ1812 | 0.177 ± 0.010 (4.50 ± 0.25) | 0.126 ± 0.010 (3.20 ± 0.25) | 0.086 (2.18) | 0.010 (0.25) | 0.030 (0.76) |

Note

- Polymer (B-termination) have increased dimensions: part length increased by 0.006" (0.15 mm)



| SELECTION CHART | | | | | | | | | | |
|----------------------------|--------|-----------|-----|--------|-----|-----|--------|-----|-----|-----|
| DIELECTRIC | | COG (NP0) | | | | | | | | |
| STYLE | | VJ0402 | | VJ0603 | | | VJ0805 | | | |
| CASE CODE | | 0402 | | 0603 | | | 0805 | | | |
| VOLTAGE (V _{DC}) | | 25 / 50 | 100 | 50 | 100 | 200 | 50 | 100 | 200 | 500 |
| VOLTAGE CODE | | X / A | B | A | B | C | A | B | C | E |
| CAP. CODE | CAP. | | | | | | | | | |
| 1R0 | 1.0 pF | •• | •• | •• | •• | •• | •• | •• | •• | •• |
| 1R2 | 1.2 pF | •• | •• | •• | •• | •• | •• | •• | •• | •• |
| 1R5 | 1.5 pF | •• | •• | •• | •• | •• | •• | •• | •• | •• |
| 1R8 | 1.8 pF | •• | •• | •• | •• | •• | •• | •• | •• | •• |
| 2R2 | 2.2 pF | •• | •• | •• | •• | •• | •• | •• | •• | •• |
| 2R7 | 2.7 pF | •• | •• | •• | •• | •• | •• | •• | •• | •• |
| 3R3 | 3.3 pF | •• | •• | •• | •• | •• | •• | •• | •• | •• |
| 3R9 | 3.9 pF | •• | •• | •• | •• | •• | •• | •• | •• | •• |
| 4R7 | 4.7 pF | •• | •• | •• | •• | •• | •• | •• | •• | •• |
| 5R6 | 5.6 pF | •• | •• | •• | •• | •• | •• | •• | •• | •• |
| 6R8 | 6.8 pF | •• | •• | •• | •• | •• | •• | •• | •• | •• |
| 8R2 | 8.2 pF | •• | •• | •• | •• | •• | •• | •• | •• | •• |
| 100 | 10 pF | •• | •• | •• | •• | •• | •• | •• | •• | •• |
| 120 | 12 pF | •• | •• | •• | •• | •• | •• | •• | •• | •• |
| 150 | 15 pF | •• | •• | •• | •• | •• | •• | •• | •• | •• |
| 180 | 18 pF | •• | •• | •• | •• | •• | •• | •• | •• | •• |
| 220 | 22 pF | ++ | ++ | •• | •• | •• | •• | •• | •• | •• |
| 270 | 27 pF | ++ | ++ | •• | •• | •• | •• | •• | •• | •• |
| 330 | 33 pF | ++ | ++ | •• | •• | •• | •• | •• | •• | •• |
| 390 | 39 pF | ++ | ++ | •• | •• | •• | •• | •• | •• | •• |
| 470 | 47 pF | ++ | ++ | •• | •• | •• | •• | •• | •• | •• |
| 560 | 56 pF | ++ | ++ | ++ | ++ | ++ | •• | •• | •• | •• |
| 680 | 68 pF | ++ | ++ | ++ | ++ | ++ | •• | •• | •• | •• |
| 820 | 82 pF | ++ | ++ | ++ | ++ | ++ | •• | •• | •• | •• |
| 101 | 100 pF | ++ | ++ | ++ | ++ | ++ | ++ | ++ | ++ | ++ |
| 121 | 120 pF | ++ | ++ | ++ | ++ | ++ | ++ | ++ | ++ | ++ |
| 151 | 150 pF | ++ | | ++ | ++ | + | ++ | ++ | ++ | ++ |
| 181 | 180 pF | ++ | | ++ | ++ | | ++ | ++ | ++ | ++ |
| 221 | 220 pF | ++ | | ++ | ++ | + | ++ | ++ | ++ | + |
| 271 | 270 pF | | | ++ | ++ | + | ++ | ++ | ++ | + |
| 331 | 330 pF | | | ++ | ++ | | ++ | ++ | ++ | + |
| 391 | 390 pF | | | ++ | ++ | | ++ | ++ | ++ | + |
| 471 | 470 pF | | | ++ | ++ | | ++ | ++ | + | + |
| 561 | 560 pF | | | ++ | | | ++ | ++ | + | |
| 681 | 680 pF | | | ++ | | | ++ | ++ | + | |
| 821 | 820 pF | | | ++ | | | ++ | ++ | + | |
| 102 | 1.0 nF | | | ++ | | | ++ | ++ | + | |
| 122 | 1.2 nF | | | | | | ++ | + | | |
| 152 | 1.5 nF | | | | | | ++ | + | | |
| 182 | 1.8 nF | | | | | | + | + | | |
| 222 | 2.2 nF | | | | | | + | | | |
| 272 | 2.7 nF | | | | | | + | | | |
| 332 | 3.3 nF | | | | | | + | | | |
| 392 | 3.9 nF | | | | | | + | | | |
| 472 | 4.7 nF | | | | | | | | | |
| 562 | 5.6 nF | | | | | | | | | |
| 682 | 6.8 nF | | | | | | | | | |
| 822 | 8.2 nF | | | | | | | | | |
| 103 | 10 nF | | | | | | | | | |
| 123 | 12 nF | | | | | | | | | |
| 153 | 15 nF | | | | | | | | | |
| 183 | 18 nF | | | | | | | | | |
| 223 | 22 nF | | | | | | | | | |
| 273 | 27 nF | | | | | | | | | |
| 333 | 33 nF | | | | | | | | | |
| 393 | 39 nF | | | | | | | | | |
| 473 | 47 nF | | | | | | | | | |
| 563 | 56 nF | | | | | | | | | |

Notes

•• Paper tape, • Plastic tape, ++ Paper tape, + Plastic tape, see table "Product drawings (in use)"

(1) See soldering recommendations within this data book, or visit www.vishay.com/doc?45034

- RoHS-compliant
- Not RoHS-compliant



| SELECTION CHART | | | | | | | | | | | | | | | | |
|----------------------------|--------|-----------------------|-----|-----|-----|-----------|-----------------------|-----|-----|-----------|----|-----------------------|-----|-----------|------|------|
| DIELECTRIC | | COG (NP0) | | | | | | | | | | | | | | |
| STYLE | | VJ1206 ⁽¹⁾ | | | | | VJ1210 ⁽¹⁾ | | | | | VJ1812 ⁽¹⁾ | | | | |
| CASE CODE | | 1206 | | | | | 1210 | | | | | 1812 | | | | |
| VOLTAGE (V _{DC}) | | 50 | 100 | 200 | 250 | 500 / 630 | 50 | 100 | 200 | 500 / 630 | 50 | 100 | 200 | 500 / 630 | 1000 | 3000 |
| VOLTAGE CODE | | A | B | C | P | E / L | A | B | C | E / L | A | B | C | E / L | G | H |
| CAP. CODE | CAP. | | | | | | | | | | | | | | | |
| 1R0 | 1.0 pF | •• | •• | •• | | •• | | | | | | | | | | |
| 1R2 | 1.2 pF | •• | •• | •• | | •• | | | | | | | | | | |
| 1R5 | 1.5 pF | •• | •• | •• | | •• | | | | | | | | | | |
| 1R8 | 1.8 pF | •• | •• | •• | | •• | | | | | | | | | | |
| 2R2 | 2.2 pF | •• | •• | •• | | •• | | | | | | | | | | |
| 2R7 | 2.7 pF | •• | •• | •• | | •• | | | | | | | | | | |
| 3R3 | 3.3 pF | •• | •• | •• | | •• | | | | | | | | | | |
| 3R9 | 3.9 pF | •• | •• | •• | | •• | | | | | | | | | | |
| 4R7 | 4.7 pF | •• | •• | •• | | •• | | | | | | | | | | |
| 5R6 | 5.6 pF | •• | •• | •• | | •• | | | | | | | | | | |
| 6R8 | 6.8 pF | •• | •• | •• | | •• | | | | | | | | | | |
| 8R2 | 8.2 pF | •• | •• | •• | | •• | | | | | | | | | | |
| 100 | 10 pF | •• | •• | •• | | •• | | | | | | | | | | |
| 120 | 12 pF | •• | •• | •• | | •• | | | | | | | | | | • |
| 150 | 15 pF | •• | •• | •• | | •• | | | | | | | | | | • |
| 180 | 18 pF | •• | •• | •• | | •• | | | | | | | | | | • |
| 220 | 22 pF | •• | •• | •• | | •• | | | | | | | | | • | • |
| 270 | 27 pF | •• | •• | •• | | •• | | | | | | | | | • | • |
| 330 | 33 pF | •• | •• | •• | | •• | | | | | | | | | • | • |
| 390 | 39 pF | •• | •• | •• | | •• | | | | | • | • | • | • | • | • |
| 470 | 47 pF | •• | •• | •• | | •• | | | | | • | • | • | • | • | • |
| 560 | 56 pF | •• | •• | •• | | •• | | | | | • | • | • | • | • | • |
| 680 | 68 pF | •• | •• | •• | | •• | | | | | • | • | • | • | • | • |
| 820 | 82 pF | •• | •• | •• | | •• | | | | | • | • | • | • | • | • |
| 101 | 100 pF | + | + | + | | + | + | + | + | + | • | • | • | • | • | • |
| 121 | 120 pF | + | + | + | | + | + | + | + | + | • | • | • | • | • | • |
| 151 | 150 pF | + | + | + | | + | + | + | + | + | • | • | • | • | • | • |
| 181 | 180 pF | + | + | + | | + | + | + | + | + | • | • | • | • | • | • |
| 221 | 220 pF | + | + | + | | + | + | + | + | + | • | • | • | • | • | • |
| 271 | 270 pF | + | + | + | | + | + | + | + | + | • | • | • | • | • | • |
| 331 | 330 pF | + | + | + | | + | + | + | + | + | • | • | • | • | • | • |
| 391 | 390 pF | + | + | + | | + | + | + | + | + | • | • | • | • | • | • |
| 471 | 470 pF | + | + | + | | + | + | + | + | + | • | • | • | • | • | • |
| 561 | 560 pF | + | + | + | | + | + | + | + | + | • | • | • | • | • | • |
| 681 | 680 pF | + | + | + | | + | + | + | + | + | • | • | • | • | • | • |
| 821 | 820 pF | + | + | + | | + | + | + | + | + | • | • | • | • | • | • |
| 102 | 1.0 nF | + | + | + | | + | + | + | + | + | • | • | • | • | • | • |
| 122 | 1.2 nF | + | + | + | | | + | + | + | + | • | • | • | • | • | • |
| 152 | 1.5 nF | + | + | + | | | + | + | + | + | • | • | • | • | • | • |
| 182 | 1.8 nF | + | + | + | | | + | + | + | + | • | • | • | • | • | • |
| 222 | 2.2 nF | + | + | + | + | | + | + | + | + | • | • | • | • | • | • |
| 272 | 2.7 nF | + | + | + | | | + | + | + | + | • | • | • | • | • | • |
| 332 | 3.3 nF | + | + | + | | | + | + | + | + | • | • | • | • | • | • |
| 392 | 3.9 nF | + | + | | | | + | + | + | + | • | • | • | • | • | • |
| 472 | 4.7 nF | + | + | | | | + | + | + | + | • | • | • | • | • | • |
| 562 | 5.6 nF | + | + | | | | + | + | + | + | • | • | • | • | • | • |
| 682 | 6.8 nF | + | + | | | | + | + | + | + | • | • | • | • | • | • |
| 822 | 8.2 nF | + | + | | | | + | + | + | + | • | • | • | • | • | • |
| 103 | 10 nF | + | + | | | | + | + | | | • | • | • | | | |
| 123 | 12 nF | | | | | | + | + | | | • | • | • | | | |
| 153 | 15 nF | | | | | | | | | | • | • | | | | |
| 183 | 18 nF | | | | | | | | | | • | | | | | |
| 223 | 22 nF | | | | | | | | | | • | | | | | |
| 273 | 27 nF | | | | | | | | | | • | | | | | |
| 333 | 33 nF | | | | | | | | | | | | | | | |
| 393 | 39 nF | | | | | | | | | | | | | | | |
| 473 | 47 nF | | | | | | | | | | | | | | | |
| 563 | 56 nF | | | | | | | | | | | | | | | |

Notes

•• Paper tape, • Plastic tape, ++ Paper tape, + Plastic tape, see table "Product drawings (in use)"

(1) See soldering recommendations within this data book, or visit www.vishay.com/doc?45034

Light Green: RoHS-compliant

Light Orange: Not RoHS-compliant



| SELECTION CHART | | | | | | | | | | | | | | | | | |
|----------------------------|--------|--------|----|----|-----|--------|----|----|-----|-----|--------|----|----|-----|-----|-----|-----|
| DIELECTRIC | | X7R | | | | | | | | | | | | | | | |
| STYLE | | VJ0402 | | | | VJ0603 | | | | | VJ0805 | | | | | | |
| CASE CODE | | 0402 | | | | 0603 | | | | | 0805 | | | | | | |
| VOLTAGE (V _{DC}) | | 16 | 25 | 50 | 100 | 16 | 25 | 50 | 100 | 200 | 16 | 25 | 50 | 100 | 200 | 250 | 500 |
| VOLTAGE CODE | | J | X | A | B | J | X | A | B | C | J | X | A | B | C | P | E |
| CAP. CODE | CAP. | | | | | | | | | | | | | | | | |
| 121 | 120 pF | •• | •• | •• | •• | | | | | | | | | | | | |
| 151 | 150 pF | •• | •• | •• | •• | | | | | | | | | | | | |
| 181 | 180 pF | •• | •• | •• | •• | | | | | | | | | | | | |
| 221 | 220 pF | •• | •• | •• | •• | | | | | | | | | | | | |
| 271 | 270 pF | •• | •• | •• | •• | | | | | | | | | | | | |
| 331 | 330 pF | •• | •• | •• | •• | | | •• | •• | •• | •• | •• | •• | •• | •• | | |
| 391 | 390 pF | •• | •• | •• | •• | •• | •• | •• | •• | •• | •• | •• | •• | •• | •• | •• | |
| 471 | 470 pF | •• | •• | •• | •• | •• | •• | •• | •• | •• | •• | •• | •• | •• | •• | •• | |
| 561 | 560 pF | •• | •• | •• | •• | •• | •• | •• | •• | •• | •• | •• | •• | •• | •• | •• | |
| 681 | 680 pF | •• | •• | •• | •• | •• | •• | •• | •• | •• | •• | •• | •• | •• | •• | •• | |
| 821 | 820 pF | •• | •• | •• | •• | •• | •• | •• | •• | •• | •• | •• | •• | •• | •• | •• | |
| 102 | 1.0 nF | •• | •• | •• | •• | •• | •• | •• | •• | •• | •• | •• | •• | •• | •• | •• | |
| 122 | 1.2 nF | •• | •• | •• | •• | •• | •• | •• | •• | •• | •• | •• | •• | •• | •• | •• | |
| 152 | 1.5 nF | •• | •• | •• | •• | •• | •• | •• | •• | •• | •• | •• | •• | •• | •• | •• | |
| 182 | 1.8 nF | •• | •• | •• | •• | •• | •• | •• | •• | •• | •• | •• | •• | •• | •• | •• | |
| 222 | 2.2 nF | •• | •• | •• | •• | •• | •• | •• | •• | •• | •• | •• | •• | •• | •• | •• | |
| 272 | 2.7 nF | •• | •• | •• | •• | •• | •• | •• | •• | •• | •• | •• | •• | •• | •• | •• | |
| 332 | 3.3 nF | •• | •• | •• | •• | •• | •• | •• | •• | •• | •• | •• | •• | •• | •• | •• | • |
| 392 | 3.9 nF | •• | •• | •• | •• | •• | •• | •• | •• | •• | •• | •• | •• | •• | •• | •• | |
| 472 | 4.7 nF | •• | •• | •• | •• | •• | •• | •• | •• | •• | •• | •• | •• | •• | •• | •• | |
| 562 | 5.6 nF | •• | •• | •• | •• | •• | •• | •• | •• | •• | •• | •• | •• | •• | •• | •• | |
| 682 | 6.8 nF | •• | •• | •• | •• | •• | •• | •• | •• | •• | •• | •• | •• | •• | •• | •• | |
| 822 | 8.2 nF | •• | •• | •• | •• | •• | •• | •• | •• | •• | •• | •• | •• | •• | •• | •• | |
| 103 | 10 nF | •• | •• | •• | •• | •• | •• | •• | •• | •• | •• | •• | •• | •• | •• | •• | •• |
| 123 | 12 nF | •• | •• | •• | •• | •• | •• | •• | •• | •• | •• | •• | •• | •• | •• | •• | |
| 153 | 15 nF | •• | •• | •• | •• | •• | •• | •• | •• | •• | •• | •• | •• | •• | •• | •• | |
| 183 | 18 nF | •• | •• | •• | •• | •• | •• | •• | •• | •• | •• | •• | •• | •• | •• | •• | |
| 223 | 22 nF | •• | •• | •• | •• | •• | •• | •• | •• | •• | •• | •• | •• | •• | •• | •• | |
| 273 | 27 nF | •• | •• | •• | •• | •• | •• | •• | •• | •• | •• | •• | •• | •• | •• | •• | |
| 333 | 33 nF | •• | •• | •• | •• | •• | •• | •• | •• | •• | •• | •• | •• | •• | •• | •• | |
| 393 | 39 nF | •• | •• | •• | •• | •• | •• | •• | •• | •• | •• | •• | •• | •• | •• | •• | |
| 473 | 47 nF | •• | •• | •• | •• | •• | •• | •• | •• | •• | •• | •• | •• | •• | •• | •• | |
| 563 | 56 nF | •• | •• | •• | •• | •• | •• | •• | •• | •• | •• | •• | •• | •• | •• | •• | |
| 683 | 68 nF | •• | •• | •• | •• | •• | •• | •• | •• | •• | •• | •• | •• | •• | •• | •• | |
| 823 | 82 nF | •• | •• | •• | •• | •• | •• | •• | •• | •• | •• | •• | •• | •• | •• | •• | |
| 104 | 100 nF | •• | •• | •• | •• | •• | •• | •• | •• | •• | •• | •• | •• | •• | •• | •• | |
| 124 | 120 nF | •• | •• | •• | •• | •• | •• | •• | •• | •• | •• | •• | •• | •• | •• | •• | |
| 154 | 150 nF | •• | •• | •• | •• | •• | •• | •• | •• | •• | •• | •• | •• | •• | •• | •• | |
| 184 | 180 nF | •• | •• | •• | •• | •• | •• | •• | •• | •• | •• | •• | •• | •• | •• | •• | |
| 224 | 220 nF | •• | •• | •• | •• | •• | •• | •• | •• | •• | •• | •• | •• | •• | •• | •• | |
| 274 | 270 nF | •• | •• | •• | •• | •• | •• | •• | •• | •• | •• | •• | •• | •• | •• | •• | |
| 334 | 330 nF | •• | •• | •• | •• | •• | •• | •• | •• | •• | •• | •• | •• | •• | •• | •• | |
| 394 | 390 nF | •• | •• | •• | •• | •• | •• | •• | •• | •• | •• | •• | •• | •• | •• | •• | |
| 474 | 470 nF | •• | •• | •• | •• | •• | •• | •• | •• | •• | •• | •• | •• | •• | •• | •• | |
| 564 | 560 nF | •• | •• | •• | •• | •• | •• | •• | •• | •• | •• | •• | •• | •• | •• | •• | |
| 684 | 680 nF | •• | •• | •• | •• | •• | •• | •• | •• | •• | •• | •• | •• | •• | •• | •• | |
| 824 | 820 nF | •• | •• | •• | •• | •• | •• | •• | •• | •• | •• | •• | •• | •• | •• | •• | |
| 105 | 1.0 μF | •• | •• | •• | •• | •• | •• | •• | •• | •• | •• | •• | •• | •• | •• | •• | |
| 125 | 1.2 μF | •• | •• | •• | •• | •• | •• | •• | •• | •• | •• | •• | •• | •• | •• | •• | |
| 155 | 1.5 μF | •• | •• | •• | •• | •• | •• | •• | •• | •• | •• | •• | •• | •• | •• | •• | |
| 185 | 1.8 μF | •• | •• | •• | •• | •• | •• | •• | •• | •• | •• | •• | •• | •• | •• | •• | |
| 225 | 2.2 μF | •• | •• | •• | •• | •• | •• | •• | •• | •• | •• | •• | •• | •• | •• | •• | |
| 275 | 2.7 μF | •• | •• | •• | •• | •• | •• | •• | •• | •• | •• | •• | •• | •• | •• | •• | |
| 335 | 3.3 μF | •• | •• | •• | •• | •• | •• | •• | •• | •• | •• | •• | •• | •• | •• | •• | |
| 395 | 3.9 μF | •• | •• | •• | •• | •• | •• | •• | •• | •• | •• | •• | •• | •• | •• | •• | |
| 475 | 4.7 μF | •• | •• | •• | •• | •• | •• | •• | •• | •• | •• | •• | •• | •• | •• | •• | |
| 565 | 5.6 μF | •• | •• | •• | •• | •• | •• | •• | •• | •• | •• | •• | •• | •• | •• | •• | |
| 685 | 6.8 μF | •• | •• | •• | •• | •• | •• | •• | •• | •• | •• | •• | •• | •• | •• | •• | |

Notes

•• Paper tape, • Plastic tape, ++ Paper tape, + Plastic tape, see table "Product drawings (in use)"

(1) See soldering recommendations within this data book, or visit www.vishay.com/doc?45034

Light Green: RoHS-compliant

Light Orange: Not RoHS-compliant



| SELECTION CHART | | | | | | | | | | | | | | | | | | |
|----------------------------|--------|-----------------------|----|----|-----|-----|-----------------------|----|----|----|-----|-----------------------|-----------|----|-----|-----|-----|-----|
| DIELECTRIC | | X7R | | | | | | | | | | | | | | | | |
| STYLE | | VJ1206 ⁽¹⁾ | | | | | VJ1210 ⁽¹⁾ | | | | | VJ1812 ⁽¹⁾ | | | | | | |
| CASE CODE | | 1206 | | | | | 1210 | | | | | 1812 | | | | | | |
| VOLTAGE (V _{DC}) | | 16 | 25 | 50 | 100 | 200 | 500 / 630 | 16 | 25 | 50 | 100 | 200 | 500 / 630 | 50 | 100 | 200 | 500 | 630 |
| VOLTAGE CODE | | J | X | A | B | C | E / L | J | X | A | B | C | E / L | A | B | C | E | L |
| CAP. CODE | CAP. | | | | | | | | | | | | | | | | | |
| 121 | 120 pF | | | | | | | | | | | | | | | | | |
| 151 | 150 pF | | | | | | | | | | | | | | | | | |
| 181 | 180 pF | | | | | | | | | | | | | | | | | |
| 221 | 220 pF | | | | | | • | | | | | | | | | | | |
| 271 | 270 pF | | | | | | • | | | | | | | | | | | |
| 331 | 330 pF | | | | | | • | | | | | | | | | | | |
| 391 | 390 pF | | | | | | • | | | | | • | | | | | | |
| 471 | 470 pF | | | | | | • | | | | | • | | | | | | |
| 561 | 560 pF | | | | | | • | | | | | • | | | | | | |
| 681 | 680 pF | | | | | | • | | | | | • | | | | | | |
| 821 | 820 pF | | | • | • | • | • | | | | | • | | | | | | |
| 102 | 1.0 nF | • | • | • | • | • | • | | | | | • | | | | | | |
| 122 | 1.2 nF | • | • | • | • | • | • | | | | | • | | | | | | |
| 152 | 1.5 nF | • | • | • | • | • | • | | | | | • | | | | | | |
| 182 | 1.8 nF | • | • | • | • | • | • | | | | | • | | | | | | |
| 222 | 2.2 nF | • | • | • | • | • | • | | | | | • | | | | | | |
| 272 | 2.7 nF | • | • | • | • | • | • | | | | | • | | | | | | |
| 332 | 3.3 nF | • | • | • | • | • | • | | | | | • | | | | | | |
| 392 | 3.9 nF | • | • | • | • | • | • | | | | | • | | | | | | |
| 472 | 4.7 nF | • | • | • | • | • | • | | | | | • | | | | | | |
| 562 | 5.6 nF | • | • | • | • | • | • | | | | | • | | | | | | |
| 682 | 6.8 nF | • | • | • | • | • | • | | | | | • | | | | | | |
| 822 | 8.2 nF | • | • | • | • | • | • | | | | | • | | | | | | |
| 103 | 10 nF | • | • | • | • | • | • | • | • | • | • | • | | | | • | • | • |
| 123 | 12 nF | • | • | • | • | • | • | • | • | • | • | • | | | | • | • | • |
| 153 | 15 nF | • | • | • | • | • | • | • | • | • | • | • | | | | • | • | • |
| 183 | 18 nF | • | • | • | • | • | + | • | • | • | • | • | | | | • | • | • |
| 223 | 22 nF | • | • | • | • | • | | • | • | • | • | • | + | • | • | • | • | • |
| 273 | 27 nF | • | • | • | • | • | | • | • | • | • | • | + | • | • | • | • | • |
| 333 | 33 nF | • | • | • | • | • | | • | • | • | • | • | + | • | • | • | • | • |
| 393 | 39 nF | • | • | • | • | • | | • | • | • | • | • | + | • | • | • | • | • |
| 473 | 47 nF | • | • | • | • | • | | • | • | • | • | • | | • | • | • | • | • |
| 563 | 56 nF | • | • | • | • | • | | • | • | • | • | • | | • | • | • | • | • |
| 683 | 68 nF | • | • | • | • | • | | • | • | • | • | • | | • | • | • | • | • |
| 823 | 82 nF | • | • | • | • | + | | • | • | • | • | • | | • | • | • | • | • |
| 104 | 100 nF | • | • | • | + | + | | • | • | • | + | + | | • | • | • | • | |
| 124 | 120 nF | • | • | • | + | + | | • | • | • | + | + | | • | • | • | • | |
| 154 | 150 nF | • | • | + | + | | | • | • | • | + | + | | • | • | • | • | |
| 184 | 180 nF | • | • | + | + | | | • | • | • | + | + | | • | • | • | • | |
| 224 | 220 nF | + | + | + | + | | | + | + | + | + | | | • | • | • | • | |
| 274 | 270 nF | + | + | + | + | | | + | + | + | + | | | • | • | • | • | |
| 334 | 330 nF | + | + | + | | | | + | + | + | + | | | • | • | | | |
| 394 | 390 nF | + | + | + | | | | + | + | + | + | | | • | • | | | |
| 474 | 470 nF | + | + | + | | | | + | + | + | + | | | • | • | | | |
| 564 | 560 nF | + | + | | | | | + | + | + | | | | • | • | | | |
| 684 | 680 nF | + | + | | | | | + | + | + | | | | • | • | | | |
| 824 | 820 nF | + | + | | | | | + | + | + | | | | • | • | | | |
| 105 | 1.0 µF | + | + | | | | | + | + | + | | | | • | | | | |
| 125 | 1.2 µF | | | | | | | | | | | | | | | | | |
| 155 | 1.5 µF | | | | | | | | | | | | | | | | | |
| 185 | 1.8 µF | | | | | | | | | | | | | | | | | |
| 225 | 2.2 µF | | | | | | | | | | | | | | | | | |
| 275 | 2.7 µF | | | | | | | | | | | | | | | | | |
| 335 | 3.3 µF | | | | | | | | | | | | | | | | | |
| 395 | 3.9 µF | | | | | | | | | | | | | | | | | |
| 475 | 4.7 µF | | | | | | | | | | | | | | | | | |
| 565 | 5.6 µF | | | | | | | | | | | | | | | | | |
| 685 | 6.8 µF | | | | | | | | | | | | | | | | | |

Notes

•• Paper tape, • Plastic tape, ++ Paper tape, + Plastic tape, see table "Product drawings (in use)"

⁽¹⁾ See soldering recommendations within this data book, or visit www.vishay.com/doc?45034

Light Green: RoHS-compliant

Light Orange: Not RoHS-compliant



| SELECTION CHART | | | | | | | | | | | | | | |
|---|--------|--------|----|-----|--------|----|-----|--------|----|-----|-----------------------|----|-----------------------|----|
| DIELECTRIC | | X8R | | | | | | | | | | | | |
| STYLE | | VJ0402 | | | VJ0603 | | | VJ0805 | | | VJ1206 ⁽¹⁾ | | VJ1210 ⁽¹⁾ | |
| CASE CODE | | 0402 | | | 0603 | | | 0805 | | | 1206 | | 1210 | |
| VOLTAGE (V _{DC}) ⁽²⁾ | | 25 | 50 | 100 | 25 | 50 | 100 | 25 | 50 | 100 | 25 | 50 | 25 | 50 |
| VOLTAGE CODE | | X | A | B | X | A | B | X | A | B | X | A | X | A |
| CAP. CODE | CAP. | | | | | | | | | | | | | |
| 101 | 100 pF | | | | | | | | | | | | | |
| 121 | 120 pF | | | | | | | | | | | | | |
| 151 | 150 pF | | | | | | | | | | | | | |
| 181 | 180 pF | | | | | | | | | | | | | |
| 221 | 220 pF | | | | | | | | | | | | | |
| 271 | 270 pF | | | | | | | | | | | | | |
| 331 | 330 pF | •• | •• | •• | | | | | | | | | | |
| 391 | 390 pF | •• | •• | •• | | | | | | | | | | |
| 471 | 470 pF | •• | •• | •• | | •• | •• | •• | •• | •• | | | | |
| 561 | 560 pF | •• | •• | •• | | •• | •• | •• | •• | •• | | | | |
| 681 | 680 pF | •• | •• | •• | •• | •• | •• | •• | •• | •• | | | | |
| 821 | 820 pF | •• | •• | •• | •• | •• | •• | •• | •• | •• | | | | |
| 102 | 1.0 nF | •• | •• | •• | •• | •• | •• | •• | •• | •• | • | • | | |
| 122 | 1.2 nF | •• | •• | •• | •• | •• | •• | •• | •• | •• | • | • | | |
| 152 | 1.5 nF | •• | •• | | •• | •• | •• | •• | •• | •• | • | • | | |
| 182 | 1.8 nF | •• | •• | | •• | •• | •• | •• | •• | •• | • | • | | |
| 222 | 2.2 nF | •• | •• | | •• | •• | •• | •• | •• | •• | • | • | | |
| 272 | 2.7 nF | •• | | | •• | •• | •• | •• | •• | •• | • | • | | |
| 332 | 3.3 nF | •• | | | •• | •• | •• | •• | •• | •• | • | • | | |
| 392 | 3.9 nF | •• | | | •• | •• | •• | •• | •• | •• | • | • | | |
| 472 | 4.7 nF | •• | | | •• | •• | •• | •• | •• | •• | • | • | | |
| 562 | 5.6 nF | •• | | | •• | •• | | •• | •• | •• | • | • | | |
| 682 | 6.8 nF | •• | | | •• | •• | | •• | •• | •• | • | • | | |
| 822 | 8.2 nF | | | | •• | •• | | •• | •• | •• | • | • | | |
| 103 | 10 nF | | | | •• | •• | | •• | •• | •• | • | • | • | • |
| 123 | 12 nF | | | | •• | •• | | •• | •• | •• | • | • | • | • |
| 153 | 15 nF | | | | •• | •• | | •• | •• | •• | • | • | • | • |
| 183 | 18 nF | | | | •• | •• | | •• | •• | •• | • | • | • | • |
| 223 | 22 nF | | | | •• | | | •• | •• | • | • | • | • | • |
| 273 | 27 nF | | | | •• | | | •• | • | • | • | • | • | • |
| 333 | 33 nF | | | | •• | | | •• | • | | • | • | • | • |
| 393 | 39 nF | | | | | | | •• | • | | • | • | • | • |
| 473 | 47 nF | | | | | | | • | • | | • | • | • | • |
| 563 | 56 nF | | | | | | | • | • | | • | • | • | • |
| 683 | 68 nF | | | | | | | • | | | • | • | • | • |
| 823 | 82 nF | | | | | | | • | | | • | • | • | • |
| 104 | 100 nF | | | | | | | • | | | • | • | • | • |
| 124 | 120 nF | | | | | | | | | | • | • | • | • |
| 154 | 150 nF | | | | | | | | | | • | | • | • |
| 184 | 180 nF | | | | | | | | | | • | | • | • |
| 224 | 220 nF | | | | | | | | | | • | | • | • |
| 274 | 270 nF | | | | | | | | | | | | • | • |
| 334 | 330 nF | | | | | | | | | | | | • | • |
| 394 | 390 nF | | | | | | | | | | | | • | |
| 474 | 470 nF | | | | | | | | | | | | | |
| 564 | 560 nF | | | | | | | | | | | | | |
| 684 | 680 nF | | | | | | | | | | | | | |
| 824 | 820 nF | | | | | | | | | | | | | |
| 105 | 1.0 μF | | | | | | | | | | | | | |
| 125 | 1.2 μF | | | | | | | | | | | | | |

Notes

•• Paper tape, • Plastic tape

(1) See soldering recommendations within this data book, or visit www.vishay.com/doc245034

(2) For other voltage ratings, please contact mlcc@vishay.com

•• RoHS-compliant

• Not RoHS-compliant



| PRODUCT DRAWING (in use) | | | | | |
|--------------------------|------------------|---|-------------|--------------------------------|-------------|
| CASE CODE | CODE | X - TERMINATION CODE (100 % MATTE TIN) | | F - TERMINATION CODE (AgPd) | |
| | | DRAWING C0G (NPO) | DRAWING X7R | DRAWING C0G (NPO) | DRAWING X7R |
| 0402 | •• = paper tape | 7175 | 9172 | 7175 | 9072 |
| | ++ = paper tape | 7172 | 7172 | 7072 | 7072 |
| 0603 | •• = paper tape | 7179 | 9155 | 7179 | 9097 |
| | ++ = paper tape | 7155 | 7155 | 7097 | 7097 |
| | • = plastic tape | - | - | 7179 | 9097 |
| | + = plastic tape | 7155 | 7155 | 7097 | 7097 |
| 0805 | •• = paper tape | 7188 | 9156 | 7188 | 9080 |
| | ++ = paper tape | 7156 | 7156 | 7080 | 7080 |
| | • = plastic tape | - | 9156 | 7188 | 9080 |
| | + = plastic tape | 7156 | 7156 | 7080 | 7080 |
| 1206 | •• = paper tape | 7180 | - | - | - |
| | • = plastic tape | - | 9157 | 7180 | 9081 |
| | + = plastic tape | 7157 | 7157 | 7081 | 7081 |
| 1210 | • = plastic tape | - | 9158 | - | 9099 |
| | + = plastic tape | 7158 | 7158 | 7099 | 7099 |

| STANDARD PACKAGING QUANTITIES (1)(2) | | | | | |
|--------------------------------------|-----------|---|---|---|---|
| CASE CODE | TAPE SIZE | 7" REEL QUANTITIES | | 11 1/4" AND 13" REEL QUANTITIES | |
| | | PAPER TAPE PACKAGING CODE "C" / "O" (4) | PLASTIC TAPE PACKAGING CODE "E" / "T" (6) | PAPER TAPE PACKAGING CODE "P" / "I" (4) | PLASTIC TAPE PACKAGING CODE "M" / "R" (6) |
| 0402 | 8 mm | 5000 / 10 000 (3) | n/a | 10 000 / 30 000 (3) | n/a |
| 0603 | 8 mm | 4000 | 4000 | 10 000 | 10 000 |
| 0805 (5) | 8 mm | 3000 | 3000 | 10 000 | 10 000 |
| 1206 (5) | 8 mm | 3000 | 2500 / 3000 | 10 000 | 9000 / 10 000 |
| 1210 (5) | 8 mm | n/a | 2000 / 2500 / 3000 | n/a | 9000 / 10 000 |
| 1812 | 12 mm | n/a | 1000 | n/a | 4000 |

Notes

- (1) Reference: EIA standard RS 481 - "Taping of Surface Mount Components for Automatic Placement"
- (2) n/a = not available
- (3) Quantity can vary with customer request
- (4) Flamed paper tape code "O" (7" reel) and "I" (11 1/4/13" reel) for AgPd terminated parts (termination code F, E)
- (5) Packaging "C/P" or "E/M" and quantity can depend from product thickness
- (6) Packaging code "T", "R" are used for size 1812.



1 - GENERAL CERTIFICATES

| | |
|---|-----|
| # Quality management system according to ISO/TS 16949: 2009 | Yes |
| # Quality management system according to ISO 9001: 2008 | Yes |
| # Environmental certification according to ISO 14001: 2004 | Yes |
| # Health and safety system according to OSHA 18001 | Yes |

2 - TECHNICAL REQUIREMENTS

Unless specified in component specification, these parameters are the minimum requirements for the components.

2.1 OPERATING TEMPERATURE RANGE

| | | |
|---|------------------------------------|-------------------------|
| For standard applications | T _A : -55 °C to +125 °C | See characteristics 2.3 |
| For high temperature applications | T _A : -55 °C to +150 °C | See characteristics 2.3 |
| For ultra high temperature applications | T _A : -55 °C to +175 °C | See characteristics 2.3 |

2.2 STORAGE AND HANDLING CONDITIONS

- (1) Store the components at 5 °C to 40 °C ambient temperature and ≤ 70 % relative humidity conditions.
 (2) The product is recommended to be used within a time-frame of 2 years after shipment.
 Check solderability in case extended shelf life beyond the expiry date is needed.

Precautions:

- Do not store products in an environment containing corrosive elements, especially where chloride gas, sulfide gas, acid, alkali, salt or the like are present. This may cause corrosion or oxidization of the terminations, which can easily lead to poor soldering.
- Store products on the shelf and avoid exposure to moisture or dust.
- Do not expose products to excessive shock, vibration, direct sunlight and so on.

2.3 CHARACTERISTICS

| PARAMETER | CERAMIC TYPE | SYMBOL | RATINGS | TEST CONDITIONS/REMARKS |
|--|--------------|----------------|--------------------------------------|---|
| Rated voltage in temperature range -55 °C to +125 °C | C0G (NP0) | U _R | 25 V to 3000 V | |
| | X7R | | 16 V to 630 V | |
| Rated voltage in temperature range -55 °C to +150 °C | X8R | | 25 V/50 V | |
| Derating at higher temperature up to +150 °C | C0G (NP0), | | 25 V to 100 V | U _{DC} ≤ 1/2 U _R |
| | X7R | | 16 V to 100 V | U _{DC} ≤ 1/2 U _R |
| Derating at higher temperature up to +175 °C | C0G (NP0), | | 25 V to 100 V | U _{DC} ≤ 1/4 U _R |
| | X7R | 16 V to 100 V | U _{DC} ≤ 1/4 U _R | |
| | X8R | 25 V/50 V | U _{DC} ≤ 1/4 U _R | |
| Temperature coefficient in temperature range -55 °C to +125 °C | C0G (NP0) | α _C | ≤ ± 30 ppm/°C | if C _R < 10 pF: α _C ≤ ± 120 ppm/K |
| | X7R | ΔC | ≤ ± 15 % | |
| Temperature coefficient in temperature range -55 °C to +150 °C | C0G (NP0) | α _C | ≤ ± 30 ppm/°C | if C _R < 10 pF: α _C ≤ ± 120 ppm/K |
| | X7R | | +15 %/-30 % | |
| | X8R | | ≤ ± 15 % | |
| Temperature coefficient in temperature range -55 °C to +175 °C | X7R | ΔC | + 15 %/-50 % | |
| Dissipation factor in temperature range -55 °C to +175 °C | C0G (NP0) | tan δ | ≤ 0.0015 | |
| | X7R | | ≤ 0.06 | |
| | X8R | | ≤ 0.06 | |



COG (NP0) DIELECTRIC - TYPICAL PARAMETERS

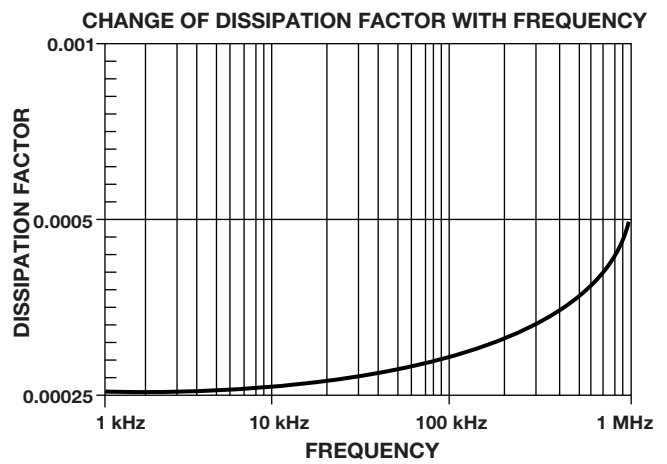
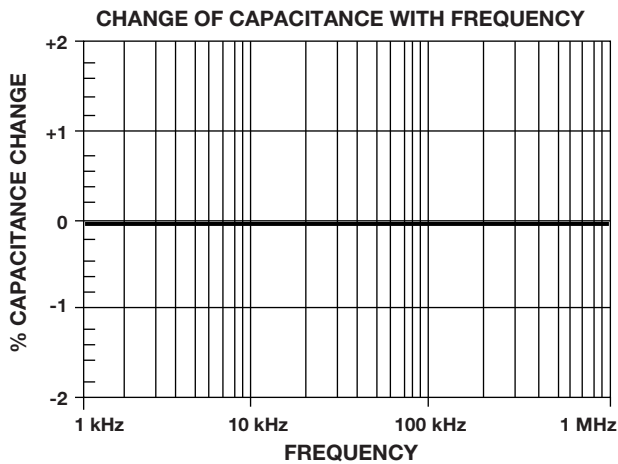
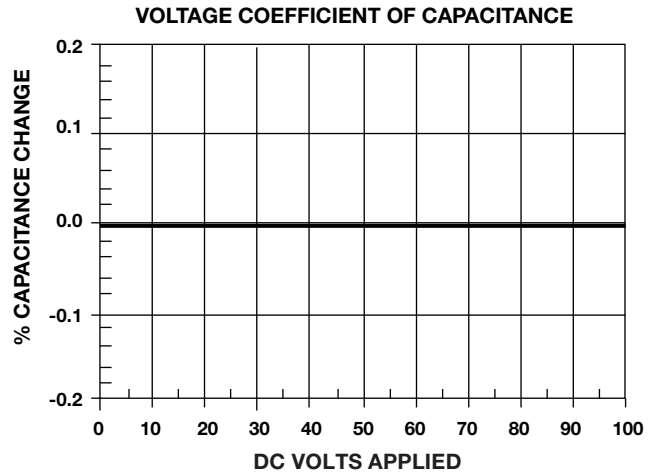
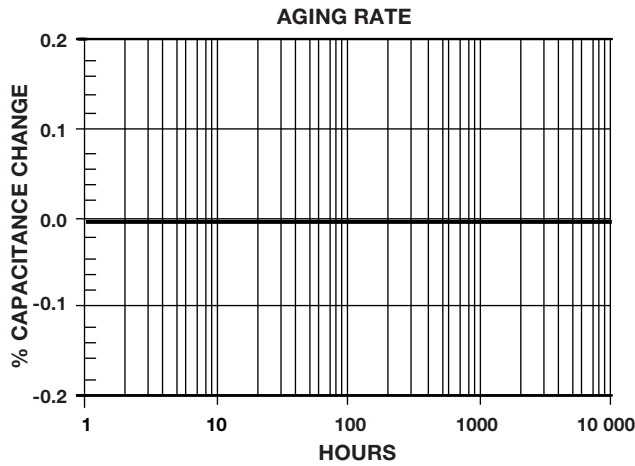
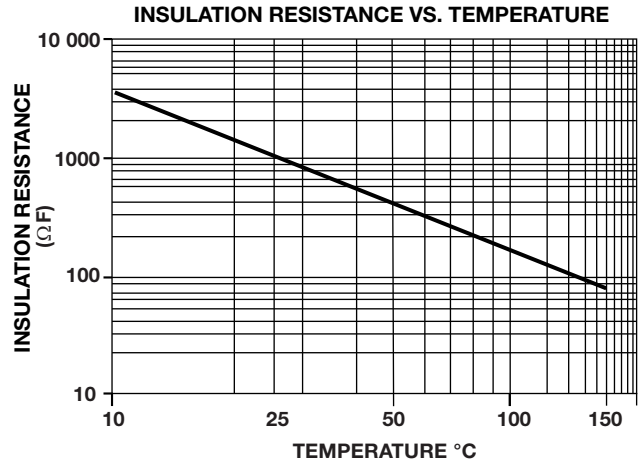
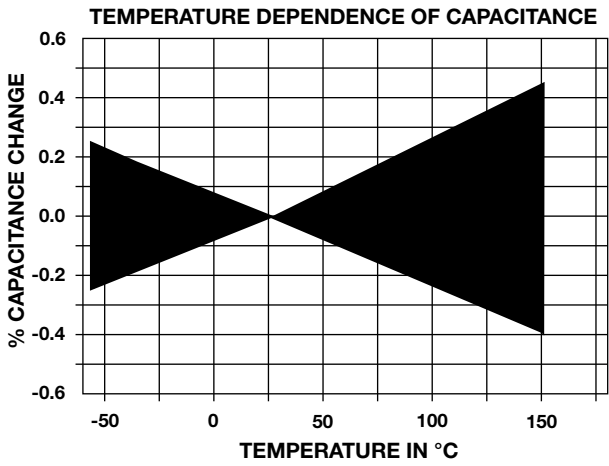



X7R DIELECTRIC - TYPICAL PARAMETERS

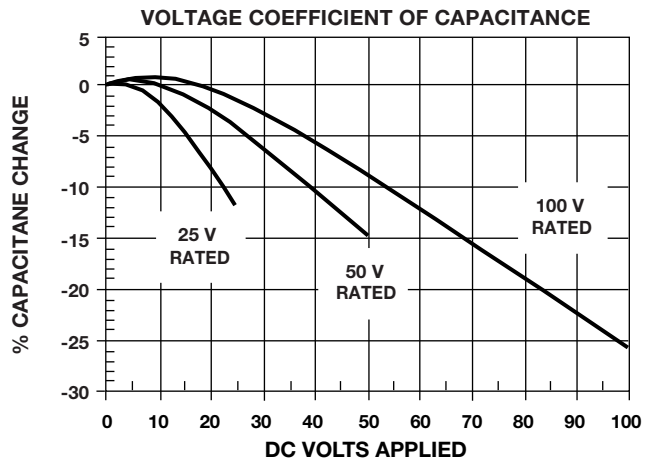
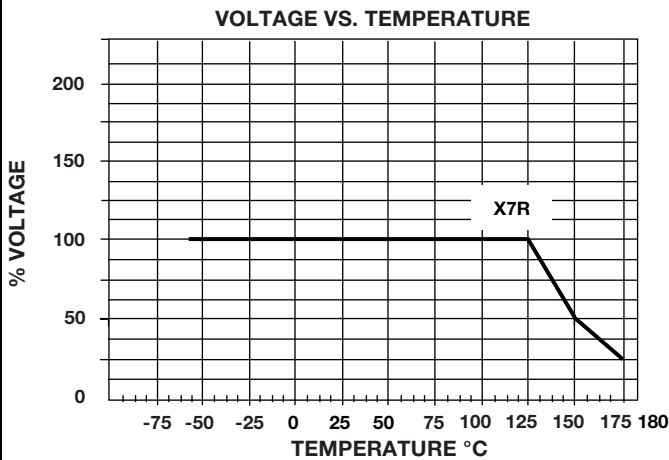
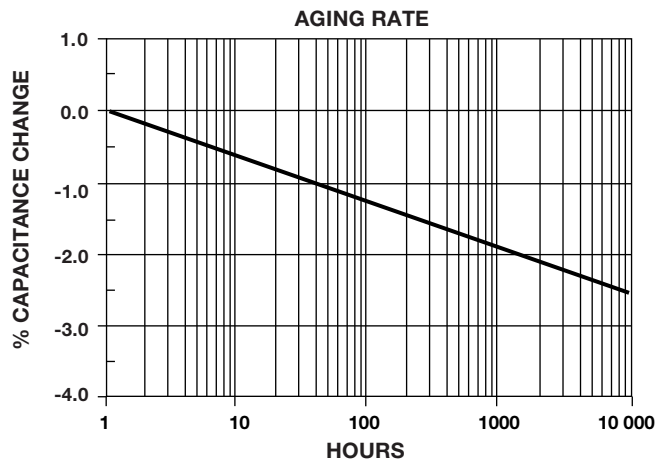
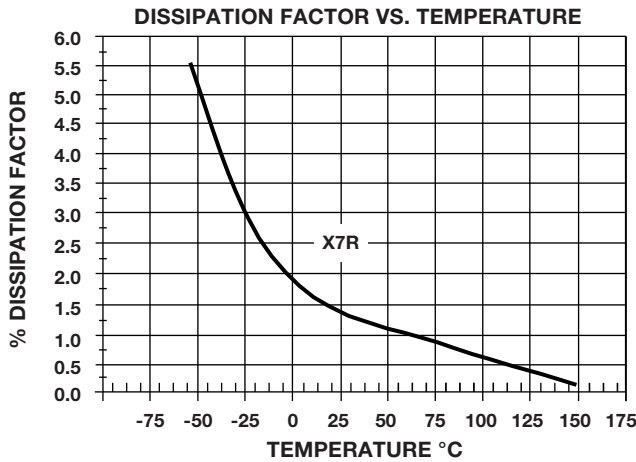
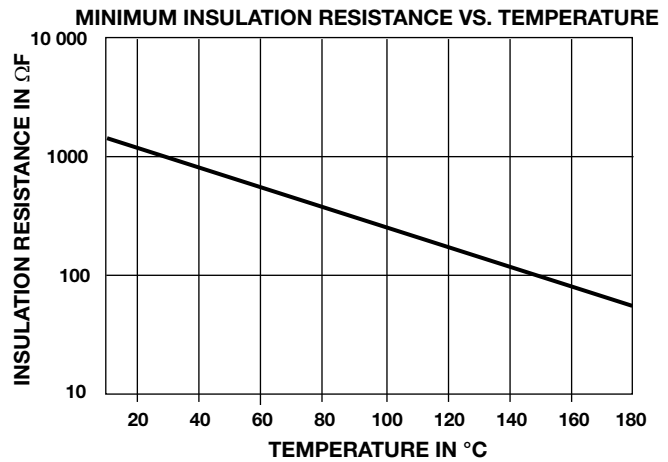
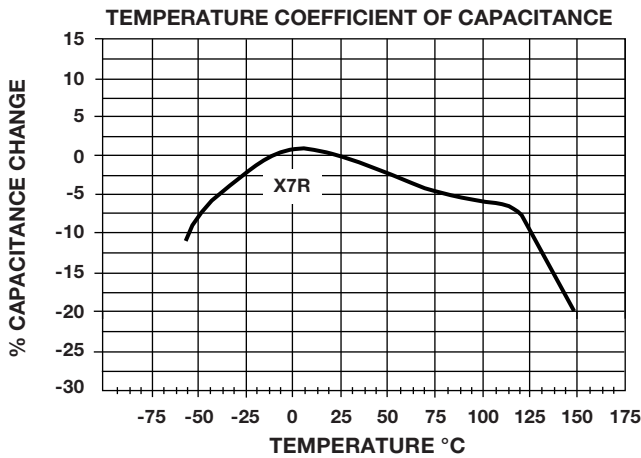



X7R DIELECTRIC - TYPICAL PARAMETERS

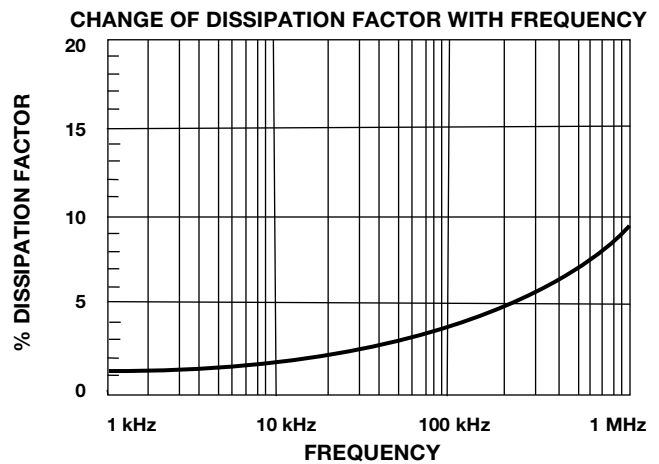
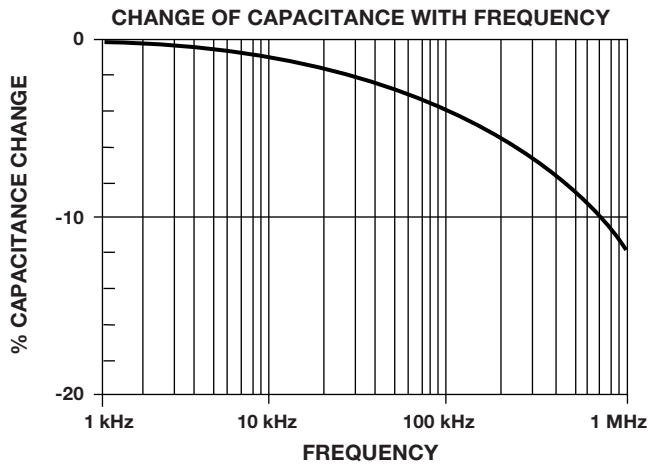
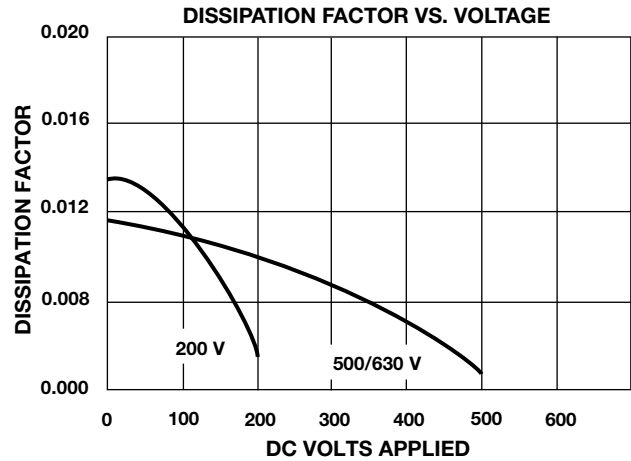
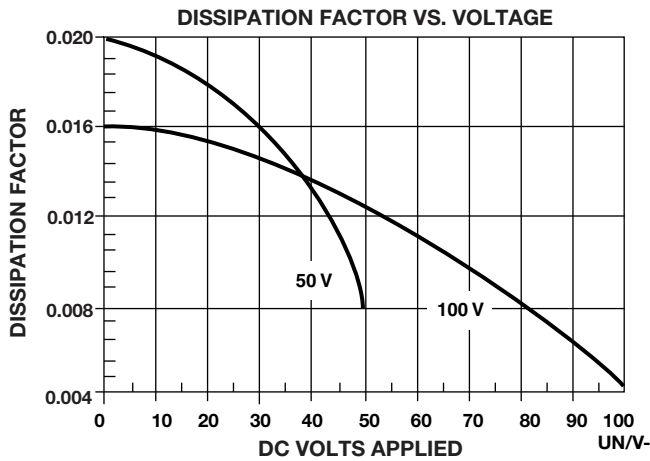



X8R DIELECTRIC - TYPICAL PARAMETERS

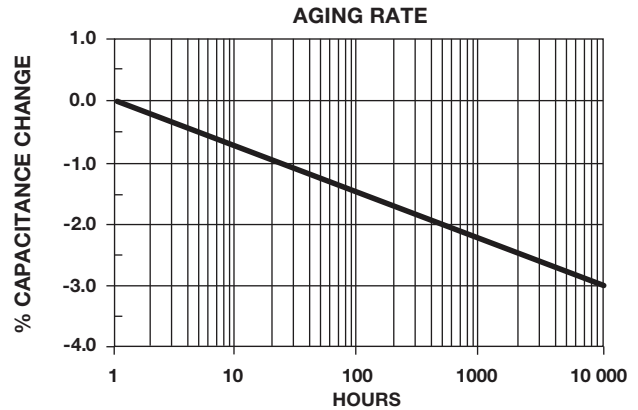
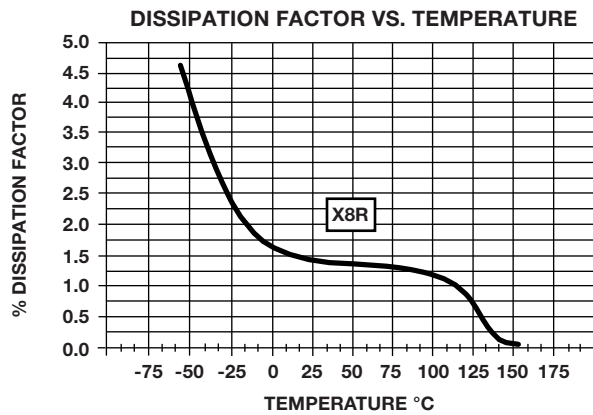
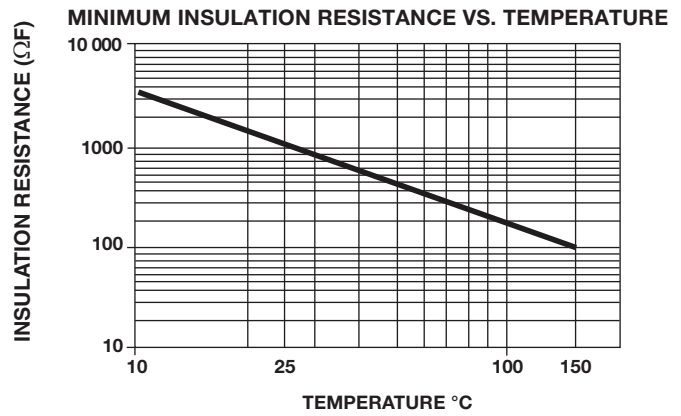
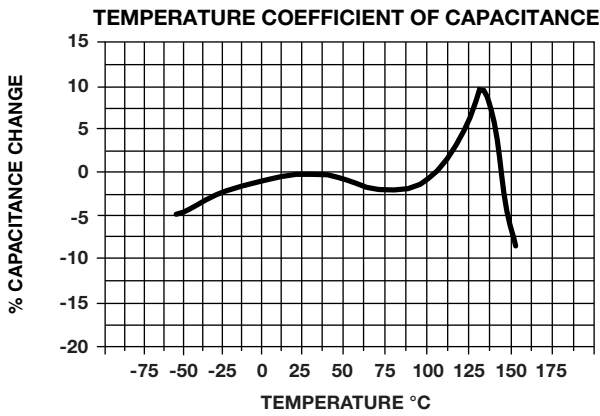

**3 - LOT ACCEPTANCE TESTS**

Process tests available in classes (on request)

| GROUP | ACTION |
|-------|---|
| A | Components are tested within the monitoring program of the supplier. The supplier shall submit the part numbers of the selected component to the customer during the component specification discussions. |
| B | Components (customer P/N) shall be tested quarterly. Records available only on special request by the customer. |
| C | Test with each shipment. Records are provided on a monthly basis. Customer special requirement; requirement should be determined in a specific component specification. |

Upon request the records can be submitted in electronic format on monthly basis.

3.1 THERMAL STRENGTH, THERMAL SHOCK SENSIBILITY

| | |
|-------------------|---|
| Sample size | 200 |
| Handling | Mounted on PCB |
| Thermal shock | 1 x 280 °C, no pre-heat, 5 s to 10 s |
| IR - test (IRATS) | $U = U_R$, $T =$ room temperature, verified |
| Burn in (BIATS) | Equivalent to 12 h burn-in, $2 \times U_R/125$ °C, verification time to failure |

Acceptance criteria: zero defects (IRATS and BIATS).

3.2 BOARD FLEX TEST

| | |
|-----------------|--|
| Sample size | 20 pcs/lot |
| X7R, X8R | Every lot |
| C0G | At least three different part numbers of one component family matrix per quarter |
| Max. deflection | 8 mm (data to be reported, available on request) |

3.3 SOLDERABILITY/RESISTANCE TO SOLDERING HEAT

Temperature profile for reflow soldering of SMD parts IPC/JEDEC-J-STD-020C.

Test is done on a regular basis for samples taken randomly out of the line.

Acceptance criteria: at least 95 % new solder and no detachment or leaching of terminations.

4 - ENVIRONMENTAL REQUIREMENTS

A list of the chemical substances content, which must not be used or whose use shall be limited by international law, is available on request.

Vishay confirms that the components specified in this specification do not contain asbestos nor cadmium, not even in the smallest volumes.

The manufacturer/supplier confirms that the component during normal handling, storage and assembly, as well as during operation in the automobile, is non toxic.



5 - INSPECTION CRITERIA

The supplier shall carry out visual examination with suitable equipment with approximately 10 x magnification and lighting appropriate to the specimen under test and the required quality level.

Chipping

The components shall be free of cracks or fissures. Small damages which do not deteriorate the performance of the component shall be less than 50 % of the surface of the MLCC as defined in EIA 595.

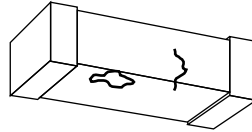

Delamination or Exposed Electrodes

No visible separation or delamination between layers of the capacitor and no exposed electrodes between the two terminals of the capacitor must be seen.

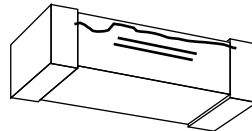

Metallization

For the metallization, no visible detachment of the metallized terminals and no exposed electrodes must be seen. Defects and gaps in the metallization on each sides of the terminal must not exceed 10 % of the total area (e.g. A, B, C, ...). Leaching shall not exceed 25 %.

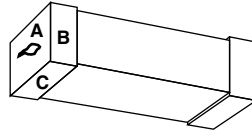

Electrode Distance

The ceramic body shall be free of any conducting material between the terminals which reduces the distance of the electrodes. The minimum distance "D" is 400 µm for all package sizes, except 0402. For the component package 0402 the minimum distance is 200 µm.

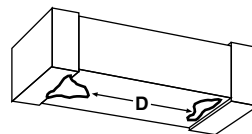



6 - BOARD FLEX TEST CONDITIONS

6.1 BOARD FLEX DEFINITIONS OF TEST

PCB thickness = (1.6 ± 0.1) mm

Copper thickness = 35 µm

Material FR4 (EP-GC 02 according to DIN 40 802)

| LAYOUT/PAD DESIGN (Dimensions in mm) | | | |
|--------------------------------------|----------|------|------|
| CASE CODE | PAD SIZE | | |
| | LL | LB | LEL |
| 0603 | 2.20 | 1.00 | 0.75 |
| 0805 | 3.40 | 1.30 | 1.20 |
| 1206 | 4.50 | 1.80 | 1.20 |
| 1210 | 4.50 | 2.80 | 1.30 |
| 1812 | 4.75 | 3.60 | 1.50 |

Note

- LL = total length; LB = width of the pad; LEL = single pad length

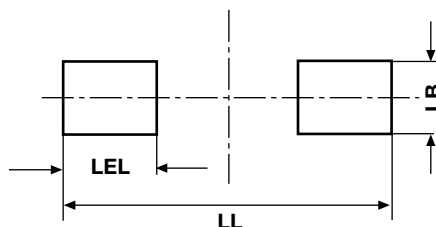

6.2 SOLDERING INSTRUCTIONS

| THICKNESS, RECOMMENDED FOR SOLDER PASTE (Reflow soldering) | |
|--|-----------------|
| CASE CODE | THICKNESS in µm |
| 0402 | 75 to 90 |
| 0603 | 150 to 200 |
| 0805 | 150 to 200 |
| 1206 | 150 to 200 |
| 1210 | 150 to 200 |
| 1812 | 150 to 200 |

6.3 TYPICAL TEMPERATURE PROFILE FOR REFLOW SOLDERING (Boardflex test)

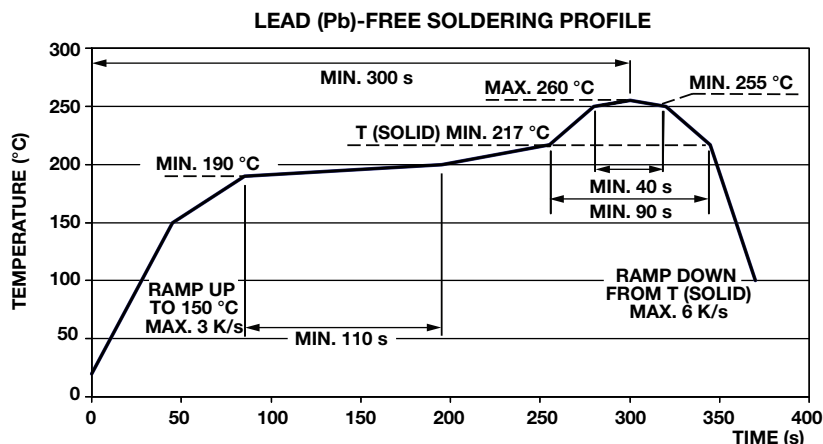



6.4 MOUNTING, DIMENSIONS AND TESTING

Mounting

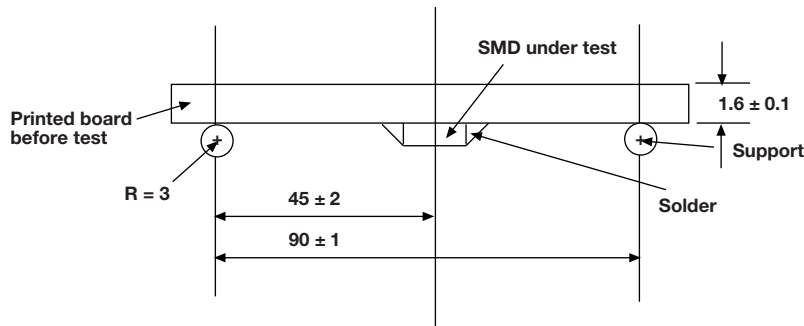

Testing

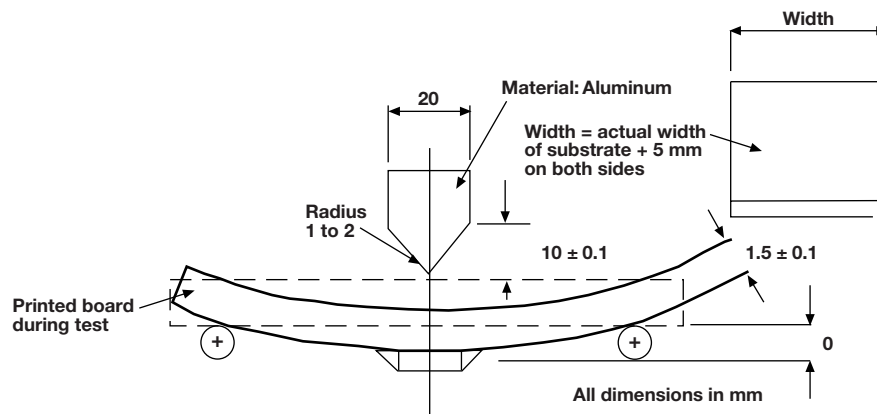

6.5 PERFORMANCE OF THE TEST(S)

- A) Electrical test according to component specification (Cap, DF, IR)
- B) Mounting to PCB
- C) Storage at room temperature (min. 10 h)
- D) Board flex test

6.6 DETAILS

| | |
|-----------------|--|
| X7R, X8R | PCB to be deflected continuously, speed 1 mm/s (± 0.5 mm/s) |
| C0G | PCB to be deflected in steps until cracks or other damages are visible or can be measured. Dwell time between steps: (5 ± 1) s |

6.7 FAILURE CRITERIA

| | |
|------------------|---|
| X7R, X8R | Piezoelectric sensor, no failures up to min. 2 mm |
| C0G (NP0) | $\Delta C/C < 1\%$ or < 1 pF, no failures up to min. 2 mm |
| Both | Electrical test according to component specification |

7 - AEC-Q200 QUALIFICATION TESTING

| NO. | AEC-Q200 TEST ITEM | REFERENCE |
|-----|--------------------------------------|-------------------------|
| 1 | Pre- and post stress electrical test | User spec |
| 3 | High temp exposure (storage) | MIL-STD-202, method 108 |
| 4 | Temperature cycling | JESD22, method JA-104 |
| 5 | Destructive physical analysis | EIA-469 |
| 6 | Moisture resistance | MIL-STD-202, method 106 |
| 7 | Biased humidity | MIL-STD-202, method 103 |
| 8 | Operation life | MIL-STD-202 method 108 |
| 9 | External Visual | MIL-STD-883 method 2009 |
| 10 | Physical dimension | JESD22, method JB-100 |
| 13 | Mechanical shock | MIL-STD-202, method 213 |
| 14 | Vibration | MIL-STD-202, method 204 |
| 15 | Resistance to solder heat | MIL-STD-202, method 215 |
| 16 | ESD | AEC-Q200 rev. C |
| 17 | Solderability | J-STD-002 |
| 20 | Electrical characterization | User spec |
| 21 | Board flex | AEC-Q200-005 |
| 22 | Terminal strength | AEC-Q200-006 |
| 23 | Beam load | AEC-Q200-003 |



Disclaimer

ALL PRODUCT, PRODUCT SPECIFICATIONS AND DATA ARE SUBJECT TO CHANGE WITHOUT NOTICE TO IMPROVE RELIABILITY, FUNCTION OR DESIGN OR OTHERWISE.

Vishay Intertechnology, Inc., its affiliates, agents, and employees, and all persons acting on its or their behalf (collectively, "Vishay"), disclaim any and all liability for any errors, inaccuracies or incompleteness contained in any datasheet or in any other disclosure relating to any product.

Vishay makes no warranty, representation or guarantee regarding the suitability of the products for any particular purpose or the continuing production of any product. To the maximum extent permitted by applicable law, Vishay disclaims (i) any and all liability arising out of the application or use of any product, (ii) any and all liability, including without limitation special, consequential or incidental damages, and (iii) any and all implied warranties, including warranties of fitness for particular purpose, non-infringement and merchantability.

Statements regarding the suitability of products for certain types of applications are based on Vishay's knowledge of typical requirements that are often placed on Vishay products in generic applications. Such statements are not binding statements about the suitability of products for a particular application. It is the customer's responsibility to validate that a particular product with the properties described in the product specification is suitable for use in a particular application. Parameters provided in datasheets and/or specifications may vary in different applications and performance may vary over time. All operating parameters, including typical parameters, must be validated for each customer application by the customer's technical experts. Product specifications do not expand or otherwise modify Vishay's terms and conditions of purchase, including but not limited to the warranty expressed therein.

Except as expressly indicated in writing, Vishay products are not designed for use in medical, life-saving, or life-sustaining applications or for any other application in which the failure of the Vishay product could result in personal injury or death. Customers using or selling Vishay products not expressly indicated for use in such applications do so at their own risk. Please contact authorized Vishay personnel to obtain written terms and conditions regarding products designed for such applications.

No license, express or implied, by estoppel or otherwise, to any intellectual property rights is granted by this document or by any conduct of Vishay. Product names and markings noted herein may be trademarks of their respective owners.

Material Category Policy

Vishay Intertechnology, Inc. hereby certifies that all its products that are identified as RoHS-Compliant fulfill the definitions and restrictions defined under Directive 2011/65/EU of The European Parliament and of the Council of June 8, 2011 on the restriction of the use of certain hazardous substances in electrical and electronic equipment (EEE) - recast, unless otherwise specified as non-compliant.

Please note that some Vishay documentation may still make reference to RoHS Directive 2002/95/EC. We confirm that all the products identified as being compliant to Directive 2002/95/EC conform to Directive 2011/65/EU.

Vishay Intertechnology, Inc. hereby certifies that all its products that are identified as Halogen-Free follow Halogen-Free requirements as per JEDEC JS709A standards. Please note that some Vishay documentation may still make reference to the IEC 61249-2-21 definition. We confirm that all the products identified as being compliant to IEC 61249-2-21 conform to JEDEC JS709A standards.